

550t

LIEBHERR LTM1550N

オールテレーンクレーン **yonehara**

クレーン部主仕様

クレーン仕様	84m仕様	50m仕様
吊上荷重	550ton×2.7m	←
メインブーム長さ	16.1~84m	16.1~50m
補助ジブ	固定式(チルトタイプ)	←
	起伏式	←
メインブーム伸縮段数	7段	4段
カウンターウエイト	135/165ton	←
第1ウインチ	ラインプル	←
	巻上速度	←
	ワイヤー長さ/径	←
第2ウインチ	ラインプル	←
	巻上速度	←
	ワイヤー長さ/径	←
第3ウインチ (起伏ジブ用)	ラインプル	←
	巻上速度	←
	ワイヤー長さ/径	←
最大地上揚程	メインブーム	←
	補助ジブ	←
旋回速度	0-1.0rpm	←
起伏速度(83度まで)	約70秒	←
ブーム伸縮速度	750秒	330秒

エンジン仕様

メーカー名	リープヘル社製
型式	D936L A6ディーゼル
冷却方式	水冷
シリンダー数	6
出力	326HP/1800rpm
最大トルク	151 kg-m/1200rpm

特徴

■ コントロール

ジョイスティックタイプの操作レバー(自動復帰式のユニバーサルコントローラ)により電気式パイロットコントロールされます。

■ 油圧駆動装置

ウインチ回路には圧力補償付流量調整弁を有し、また、自動出力調整装置付油圧ポンプにより駆動されます。

■ 安全装置および指示計

LICCON(リーコン) 過負荷防止計が装備され、吊上げ総荷重、作業半径、ブーム長さ、揚程及びアウトリガ反力等がデジタルで表示されます。

過巻防止装置、ドラム回転計、過巻出し防止装置、油圧安全弁、油圧システム保護用安全バルブが装備されています。

キャビンが20度までチルトバックします。

フック仕様

容量 (ton)	シーブ数
550	13×2
274	13
247.5	11
171	7
84.5	3
37	1
12.5	—

フックはオプション設定ですので上記の中からお選びください。



メインブーム84m仕様

550 t

LIEBHERR LTM1550N

オールテレーンクレーン yonehara

LTM1550N

キャリア部主仕様

軸数	8
最高速度	75km/h
総輪数	16
定員	2名
タイヤ	14.00 R25
登坂能力* (低速切換時)	約17.2°
最小回転半径	11.99m

*登坂時の路面状況により、能力も多少異なります。

エンジン仕様

メーカー名	リープヘル社製
型式	D9508 A7ディーゼル
冷却方式	水冷
シリンダー数	8
出力	680HP/1900rpm
最大トルク	306kg-m/1400rpm
燃料タンク	約600 ℓ

特徴

■ トランスミッション

ZF製ギアボックス付ミッションで“TC-TRONIC”自動制御システムを採用しています。
トルクコンバーター及びインターダーを内蔵しています。
前進12段、後進2段となっております。

■ サスペンション

全輪ハイドロニューマチックサスペンションであり、自動水平復帰機能（ニポー）を有しています。
状況に応じて車高を上下に調整可能です。
全輪油圧サスペンションをロックすることが可能です。

■ ステアリング

油圧源として1つは通常時、エンジンで駆動され、もう1つは非常用として駆動軸より駆動されます。

■ 常用ブレーキ

2回路式サーボブレーキが全軸に装備されています。
また、エディカレント式電磁ブレーキ（オプション）を装備しています。

■ パーキング用ブレーキ

スプリング作動のブレーキが第4～8軸に作動します。

走行速度

14.00R25 (km/h)	1	2	3	4	5	6	7	8	9	10	11	12	R ₁	R ₂	37.4%
	5.2	6.7	8.7	11.1	14.1	18	23.8	30.5	39.5	50.6	64.2	75	5.6	7.2	

駆動部

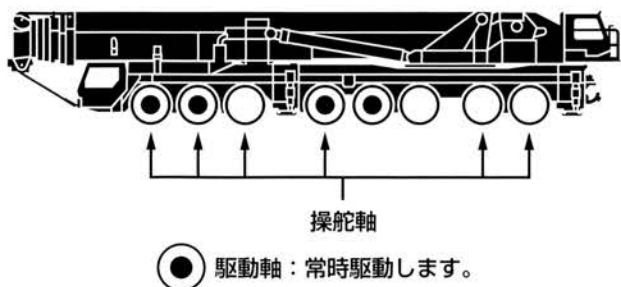

550 t

LIEBHERR LTM1550N

オールテレーンクレーン **yonehara**

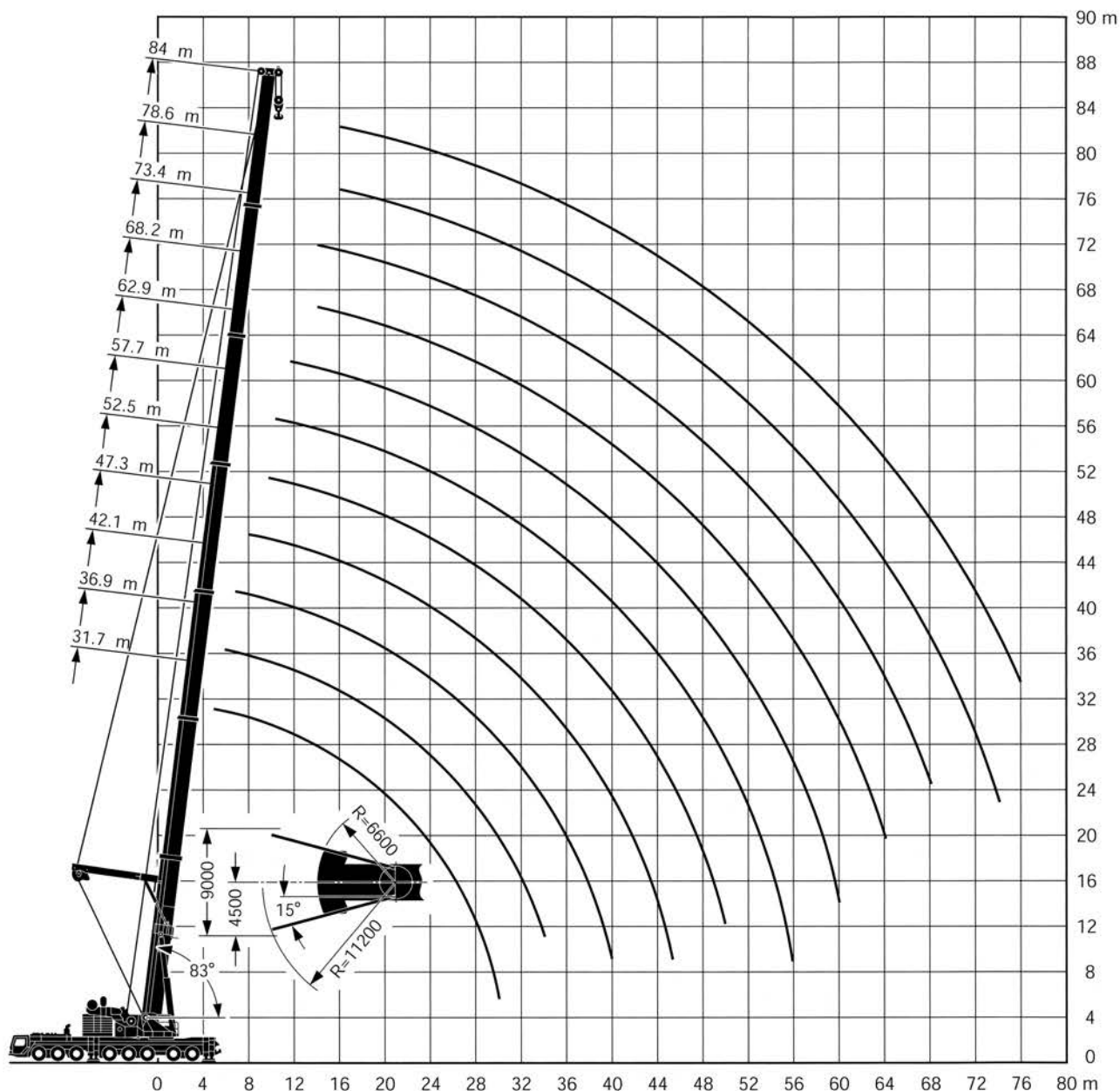

注意

- 1 定格総荷重はフックブロック、玉掛ワイヤー等の自重を含みます。
また、下記の条件が考慮されていませんのでクレーンの操作には充分気をつけてください。
 - ① 地盤の強度、地震による影響
 - ② 作業速度に応じた動荷重および台風または強風による影響等
- 2 本機は水平に設置して、クレーン作業を行ってください。
- 3 作業半径は、クレーンの旋回中心から荷重の重心までの水平距離です。
- 4 メインブームの定格総荷重は補助ジブを取り除いた状態での値です。
- 5 メインブーム84m仕様で262トンを超える定格総荷重の場合は、特殊吊装置が必要です。

550t

LIEBHERR LTM1550N

オールテレーンクレーン yonehara



16.1m-84m



10m×9.6m



360°



135t

メインブーム 作業半径(m) 長さ	16.1m		21.3m	26.5m	31.7m	36.9m	42.1m	
	1)	2)						
3	550	550	274					
3.5	440	440	274	274				
4	358	358	274	274	273			
4.5	288	288	274	274	263			
5	287	280	269	267	252	201		
6	254	248	237	235	229	184	159	
7	227	222	212	209	209	172	146	
8	205	200	190	187	187	160	135	
9	187	178	171	169	169	148	126	
10	171	159	155	152	152	137	117	
12	140	130	129	126	126	118	101	
14	118	110	109	106	106	102	88	
16				90	90	91	79	
18				78	78	78	71	
20				61	67	68	64	
22					59	60	58	
24					52	53	51	
26						46.5	45	
28						41.5	39.5	
30						36	35	
32							31	
34							27.8	
36								
38								
40								
ブーム 伸長率 (%)								
I		0		46	46	92/46	92	92/46
II		0		0	46	46/46	46	92/92
III		0		0	0	0/46	46	46/92
IV		0		0	0	0/0	0	0/0
V		0		0	0	0/0	0	0/0
VI		0		0	0	0/0	0	0/0

1) 後方吊り、165tカウンターウエイト

2) 後方吊り、135tカウンターウエイト

TAB 218232,218234,218235.1/2



16.1m-84m

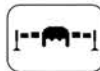

10m×9.6m



360°



135t

メインブーム 作業半径(m) 長さ	47.3m	52.5m	57.7m	62.9m	68.2m	73.4m	78.6m	84m
	8	102						
9	96	80						
10	90	76	66					
12	79	69	60	51	45			
14	70	63	54	47	41.5	36.5		
16	62	57	49.5	43	38.5	34	30	23
18	56	51	45.5	39.5	35.5	31.5	28.4	21.4
20	49.5	46	42	36.5	33	29.4	26.6	20
22	44	41.5	38.5	33.5	30.5	27.4	24.8	18.5
24	40.5	37	35	31	28.5	25.5	23.2	17.1
26	37.5	33.5	32	28.5	26.5	23.8	21.8	15.9
28	34.5	31	29.4	26.4	24.7	22.2	20.4	14.7
30	31.5	28.6	27.3	24.4	22.8	20.5	19.1	13.7
32	29.3	26.4	25.3	22.6	20.9	19.1	17.9	12.5
34	27	24.4	23.5	20.9	19.2	17.7	16.5	11.2
36	24.8	22.6	21.8	19.1	17.7	16.5	15.3	10.2
38	22.3	20.8	20.2	17.3	16.5	15.3	14.2	9.2
40	19.8	19.1	18.6	15.6	15.4	14.2	13.2	8.4
42	17.7	17.5	17.2	14.5	14.3	13.2	12.3	7.6
44	15.7	16	15.7	13.4	13.1	12.1	11.4	6.8
46	10.1	14.5	14.4	12.3	12	11.1	10.5	6
48		13	13.1	11.3	10.9	10.2	9.7	5.3
50		9.6	11.8	10.3	9.8	9.6	8.9	4.6
52			10.6	9.4	9	8.9	8.4	4.2
54			9.4	8.5	8.3	8.3	7.9	3.8
56			5.7	7.6	7.7	7.6	7.4	3.5
58				6.8	7	7	7	3.1
60				6	6.4	6.4	6.5	2.8
62					5.8	5.8	6	2.5
64					5.2	5.3	5.5	2.1
66					3.5	4.7	5	1.9
68						4.2	4.5	
70						3.7	4.1	
72							3.6	
74							3.2	
ブーム 伸長率 (%)								
I	92/0	92/0	92/0	92/0	92/0	92	92	100
II	92/0	92/0	92/92	92/46	92/92	92	92	100
III	92/92	92/46	92/92	92/92	92/92	92	92	100
IV	0/92	46/92	46/92	92/92	92/92	92	92	100
V	0/46	0/92	46/46	46/92	46/92	92	92	100
VI	0/46	0/92	0/46	0/92	46/92	46	92	100

TAB 218235.2/3

550t

LIEBHERR LTM1550N

オールテレーンクレーン yonehara



16.1m-84m



10m×9.6m



360°



105t

メインブーム長さ		16.1m	21.3m	26.5m	31.7m	36.9m	42.1m
作業半径(m)	長さ	1)					
3		262	262				
3.5		262	262	262			
4		262	262	262	248		
4.5		262	255	253	239		
5		249	238	236	229	183	
6		221	210	208	207	168	
7		195	186	183	183	156	145
8		170	165	163	162	145	133
9		150	147	145	145	134	123
10		134	133	130	130	124	114
12		109	109	107	106	107	106
14		91	91	88	88	89	92
16				74	74	75	80
18				63	63	64	71
20				55	54	54	62
22					46.5	47	53
24					40.5	41	45.5
26						36	39.5
28						31.5	34.5
30						28	29.8
32							26
34							22.7
36							19.9
38							
40							
ブーム伸長率 (%)	I	0	46/ 0	46	92/46	92	92/46
	II	0	0/ 0	46	46/46	46	92/92
	III	0	0/ 0	0	0/46	46	46/92
	IV	0	0/ 0	0	0/ 0	0	0/ 0
	V	0	0/ 0	0	0/ 0	0	0/ 0
	VI	0	0/46	0	0/ 0	0	0/ 0

1) 後方吊り

TAB 231005,231008.1/2



16.1m-84m

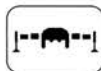

10m×9.6m



360°

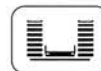

105t

メインブーム長さ		47.3m	52.5m	57.7m	62.9m	68.2m	73.4m	78.6m	84m
8		93							
9		87	73						
10		81	69	60					
12		72	63	54	46.5	41			
14		63	57	49.5	43	38	33.5		
16		57	52	45	39	35	31	27.4	20.9
18		50	46	41.5	36	32.5	28.8	25.8	19.5
20		45	41.5	38	33	30	26.8	24.2	18.2
22		40	37.5	35	30.5	27.8	24.9	22.6	16.8
24		36.5	34	32	28.2	25.9	23.2	21.1	15.6
26		34	30.5	28.9	25.9	24.1	21.6	19.8	14.4
28		30	28.1	26.8	24	22.5	20.2	18.6	13.4
30		26.4	26	24.8	22.2	20.7	18.6	17.4	12.4
32		23	24	23	20.6	19	17.3	16.3	11.4
34		20.1	21.1	21.4	19	17.5	16.1	15	10.2
36		17.6	18.6	19.7	17.4	16.1	15	13.9	9.2
38		15.3	16.3	17.4	15.8	15	13.9	12.9	8.4
40		13.2	14.2	15.3	14.2	14	12.9	12	7.6
42		11.4	12.3	13.5	13.2	13	12	11.2	6.9
44		10.2	11.2	11.8	12.1	11.9	11	10.3	6.2
46		9.2	10.3	10.2	10.8	10.9	10.1	9.5	5.5
48			9.5	8.8	9.4	9.9	9.3	8.8	4.8
50			8.8	7.7	8	8.9	8.7	8.1	4.2
52				6.8	7.4	7.9	8.1	7.6	3.8
54				6	6.9	6.7	7.5	7.2	3.5
56				5.2	6.4	5.6	6.4	6.7	3.2
58					5.9	4.7	5.6	6.3	2.8
60					5.4	4.2	5.2	5.2	2.5
62						3.9	4.8	4.6	2.2
64						3.5	4.5	4	1.9
66						3.2	4.1	3.5	
68							3.7	3	
70							3.4	2.6	
72								2.1	
74								1.7	
ブーム伸長率 (%)	I	92/ 0	92/ 0	92/ 0	92/ 0	92/ 0	92/46	92	100
	II	92/ 0	92/ 0	92/92	92/46	92/92	92/92	92	100
	III	92/92	92/46	92/92	92/92	92/92	92/92	92	100
	IV	0/92	46/92	46/92	92/92	92/92	92/92	92	100
	V	0/46	0/92	46/46	46/92	46/92	92/92	92	100
	VI	0/46	0/92	0/46	0/92	46/92	46/92	92	100

TAB 231008.2/3

550t

LIEBHERR LTM1550N

オールテレーンクレーン yonehara



31.7m-84m



10m×9.6m



360°



165t



Y-ガイ

メインブーム長さ 作業半径(m)	31.7m	36.9m	42.1m	47.3m	52.5m	57.7m	62.9m	68.2m	73.4m	78.6m	84m	
5	205											
6	200	169										
7	194	163	129									
8	185	158	125	123								
9	169	152	121	118	113							
10	154	144	117	114	109	96						
12	132	126	110	107	102	91	81					
14	114	109	104	101	96	86	78	70	62			
16	98	101	93	95	90	81	74	67	59	52	44	
18	88	89	83	85	81	76	70	64	57	49.5	42.5	
20	81	81	80	77	75	72	66	61	55	47.5	40.5	
22	72	72	71	72	68	67	63	58	52	45.5	38.5	
24	64	65	66	65	63	62	59	54	50	44	37	
26	58	60	59	58	59	57	55	51	47.5	42	35.5	
28	52	54	54	55	54	52	52	47.5	45	40.5	34	
30	40.5	49.5	49	50	48.5	48.5	47.5	45.5	42.5	39	32.5	
32		45	44.5	46	44.5	45.5	43.5	43	39.5	37.5	31	
34		40.5	41	42.5	40.5	42	40	40.5	36.5	35.5	29.8	
36			37.5	39	37.5	38.5	36.5	37.5	34	34	28.5	
38			34.5	36	34.5	35.5	33.5	34.5	31	31.5	27.2	
40			27.1	33	31.5	32.5	30.5	31.5	28.6	29.2	26.2	
42				30.5	29	30	28.1	29.2	26.4	27	25.1	
44				27.2	26.8	28	25.9	27	24.2	25	24.1	
46				16.7	24.8	25.9	23.8	24.9	22.1	23.2	22.9	
48					22.9	24	22	23	20.3	21.4	21.3	
50					17.6	22.3	20.2	21.3	18.5	19.6	19.7	
52						20.7	18.6	19.7	16.9	18	18.2	
54						17.8	17.2	18.2	15.5	16.5	16.8	
56						11.8	15.8	16.9	14.1	15.2	15.4	
58							13.9	15.6	12.8	13.9	14.1	
60							10.2	14.4	11.5	12.7	12.9	
62								13.3	10.3	11.4	11.8	
64								10.7	9.1	10.2	10.8	
66									7.9	9.1	9.8	
68									6.5	8	8.9	
70										7	8	
72										5.9	7.2	
74										4.5	6.4	
76											5.5	
78											4.2	
ブーム伸長率 (%)	I	46/0	92/0	92/0	92/0	46/0	0/0	92/0	92/0	92	92	100
	II	46/0	46/0	92/0	92/0	92/0	92/0	92/92	92/92	92	92	100
	III	46/0	46/0	46/0	92/0	92/92	92/92	92/92	92/92	92	92	100
	IV	0/0	0/0	0/92	0/92	46/92	92/92	92/92	92/92	92	92	100
	V	0/92	0/92	0/92	0/92	46/92	46/92	46/92	46/92	92	92	100
	VI	0/46	0/92	0/46	0/92	0/46	46/92	0/46	46/92	46	92	100

TAB 218020



31.7m-84m

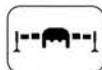

10m×9.6m



360°



135t



Y-ガイ

メインブーム長さ 作業半径(m)	31.7m	36.9m	42.1m	47.3m	52.5m	57.7m	62.9m	68.2m	73.4m	78.6m	84m	
5	205											
6	200	169										
7	194	163	129									
8	185	158	125	123								
9	169	152	121	118	113							
10	154	144	117	114	109	96						
12	127	126	110	107	102	91	81					
14	107	108	104	101	96	86	78	70	62			
16	97	96	90	93	90	81	74	67	59	52	44	
18	86	86	83	82	80	76	70	64	57	49.5	42.5	
20	75	75	76	75	71	71	66	61	55	47.5	40.5	
22	66	68	68	67	67	63	63	58	52	45.5	38.5	
24	59	61	61	62	60	59	57	53	50	44	37	
26	52	55	54	56	54	55	51	50	47	42	35.5	
28	47	49.5	49	50	48.5	50	47	47	42.5	40.5	34	
30	40.5	44.5	44	45.5	44	45	42.5	43	39	39	32.5	
32		40.5	40	41.5	40	41	39	39.5	35.5	36	31	
34		37	36.5	38	36.5	37.5	35.5	36	32.5	33	29.8	
36			33	35	33	34.5	32	33	29.6	30	28.5	
38			30.5	32	30	31.5	29.3	30.5	27	27.6	27.2	
40			27.1	29.3	27.6	28.8	26.7	27.8	24.7	25.4	25	
42				26.9	25.3	26.4	24.3	25.4	22.6	23.3	23	
44				24.8	23.2	24.3	22.2	23.3	20.5	21.5	21.2	
46				16.7	21.2	22.4	20.3	21.4	18.6	19.7	19.5	
48					19.5	20.7	18.5	19.6	16.8	17.9	18	
50					17.6	19.1	16.9	18	15.2	16.3	16.5	
52						17.6	15.4	16.5	13.7	14.8	15.1	
54						11.8	16.2	15.1	12.4	13.5	13.7	
56							12.8	13.9	11.1	12.2	12.4	
58							11.6	12.7	9.9	11	11.2	
60							10.2	11.6	8.8	9.9	10.1	
62								10.6	7.8	8.9	9.1	
64								9.6	6.8	7.9	8.1	
66									6	7	7.2	
68									5.2	6.2	6.4	
70										5.4	5.5	
72										4.8	5	
74										4.2	4.4	
76											3.8	
78											3.1	
ブーム伸長率 (%)	I	46/0	92/0	92/0	92/0	0/0	0/0	92/0	92/0	92	92	100
	II	46/0	46/0	92/0	92/0	92/0	92/0	92/92	92/92	92	92	100
	III	46/0	46/0	46/0	92/0	92/92	92/92	92/92	92/92	92	92	100
	IV	0/92	0/0	0/92	0/92	92/92	92/92	92/92	92/92	92	92	100
	V	0/46	0/92	0/92	0/92	46/92	46/92	46/92	46/92	92	92	100
	VI	0/0	0/92	0/46	0/92	0/46	46/92	0/46	46/92	46	92	100

TAB 218021

550t

LIEBHERR LTM1550N

オールテレーンクレーン **yonehara**

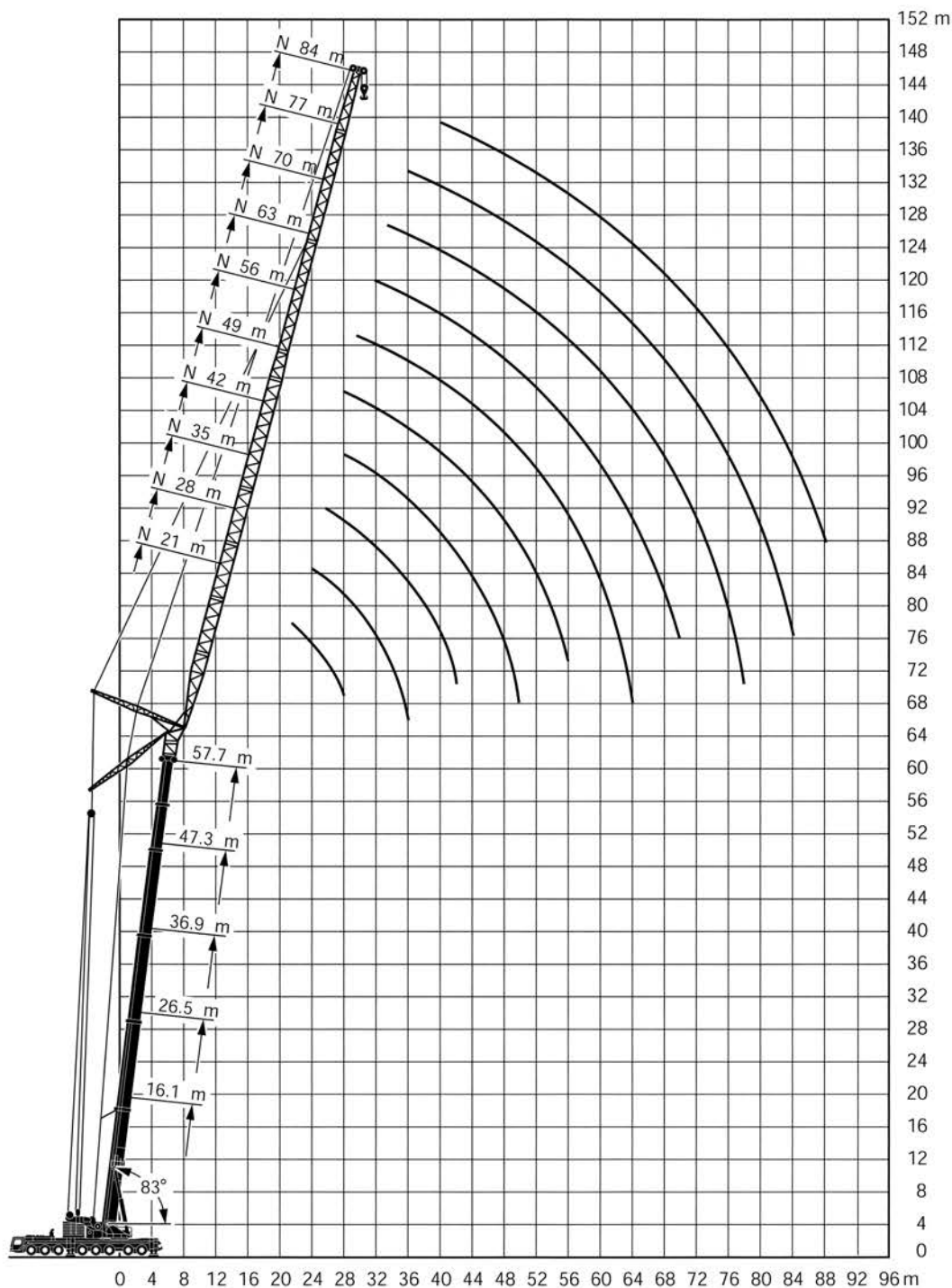

注意

- 1 定格総荷重はフックブロック、玉掛ワイヤー等の自重を含みます。
また、下記の条件が考慮されていないのでクレーンの操作には充分気をつけてください。
 - ① 地盤の強度、地震による影響
 - ② 作業速度に応じた動荷重および台風または強風による影響等
- 2 本機は水平に設置して、クレーン作業を行ってください。
- 3 作業半径は、クレーンの旋回中心から荷重の重心までの水平距離です。
- 4 メインブームの定格総荷重は補助ジブを取り除いた状態での値です。
- 5 メインブーム84m仕様で262トンを超える定格総荷重の場合は、特殊吊装置が必要です。

550t

LIEBHERR LTM1550N

オールテレーンクレーン yonehara



75°
16.1m-
78.6m



21m-
91m

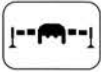

10m×9.6m



360°



165t

作業半径(m)	36.9m+4m*											47.3m+4m*										
	21m	28m	35m	42m	49m	56m	63m	70m	77m	84m	91m	21m	28m	35m	42m	49m	56m	63m	70m	77m	84m	91m
24	49																					
26	45.5	44																				
28	42.5	41																				
30	40.5	38.5	37.5																			
32	39	36	35																			
34		34.5	33																			
36		31.5	30	28.9																		
38		29.6	28.5	27.3																		
40		28.7	27.1	25.8	24.2																	
42		27.9	25.7	24.5	23.1	21.4																
44		27.2	24.9	23.3	22	20.4																
46		26.4	24.1	22.2	20.9	19.4	17.7															
48			23.4	21.2	20	18.6	17	15.5														
50			22.7	20.6	19	17.7	16.3	14.9														
52			22.1	20.2	18.2	16.9	15.6	14.4	13													
54			19.7	17.6	16.2	14.9	13.8	12.6														
56			19.3	17	15.4	14.2	13.3	12.1	10.4													
58			18.8	16.5	14.6	13.6	12.8	11.8	10.7													
60			18.4	16.1	14.1	12.9	12.2	11.4	9.7													
62				15.6	13.8	12.2	11.6	11	9.3													
64				15.2	13.5	11.6	11	10.5	8.7													
66				14.7	13.2	11.3	10.3	10	8.7													
68					12.9	10.9	9.8	9.4	8.2													
70					12.6	10.6	9.3	8.8	7.6													
72					12.3	10.3	9.1	8.3	7.1													
74					12.1	10	8.8	7.8	6.6													
76						9.7	8.6	7.6	6.1													
78						9.4	8.4	7.3	5.7													
80						9.1	8.2	7.1	5.3													
82						8	6.8	5.2														
84						7.8	6.6	5.1														
86						7.6	6.4	4.9														
88						7.5	6.2	4.8														
90							5.9	4.7														
92							5.7	4.6														
94							5.5	4.4														
96								4.4														
98								4.3														
100								4.2														
ブーム伸長率 (%)	I					92										92						
	II					46										92						
	III					46										92						
	IV					0										0						
	V					0										0						
	VI					0										0						

*アダプター

TAB 218250.3/4



75°
16.1m-
78.6m



21m-
70m

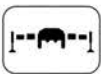

10m×9.6m



360°



165t

作業半径(m)	57.7m+4m*											68.2m+4m*					78.6m+4m*	
	21m	28m	35m	42m	49m	56m	63m	70m	21m	28m	35m	42m	49m	21m	28m			
30	18.7																	
32	17.5																	
34	16.4	14.8							9.3									
36	15.4	13.8							8.6									
38		12.9	11.8						7.9	5.8					3.2			
40		12.1	11.1	9.9					7.2	5.4	4.6				3			
42		11.4	10.4	9.2					5	4.3	3.1				2.7			
44		10.8	9.7	8.5	7.1				4.7	4	3.1				2.7			
46			9.1	7.9	6.5	4.9			4.4	3.7	2.8				2.7			
48			8.6	7.3	5.9	4.6				3.4	2.6				2.7			
50			8.2	6.7	5.4	4.3	3.3			3.2	2.4	1.6			2.7			
52				6.4	5.1	4	3			3	2.1	1.3			2.7			
54				6.1	4.8	3.7	2.7	1.8		2.9	2	1.1			2.7			
56				5.8	4.5	3.4	2.5	1.6			1.8				2.7			
58				5.6	4.4	3.2	2.2	1.3			1.7				2.7			
60					4.2	3	2	1.1			1.5				2.7			
62					4	2.8	1.8								2.7			
64					3.8	2.6	1.5								2.7			
66						2.5	1.4								2.7			
68						2.3	1.2								2.7			
70						2.2	1.1								2.7			
72						2.1	1								2.7			
ブーム伸長率 (%)	I					92									92			
	II					92									92			
	III					92									92			
	IV					46									92			
	V					46									92			
	VI					0									92			

*アダプター

TAB 218250.5

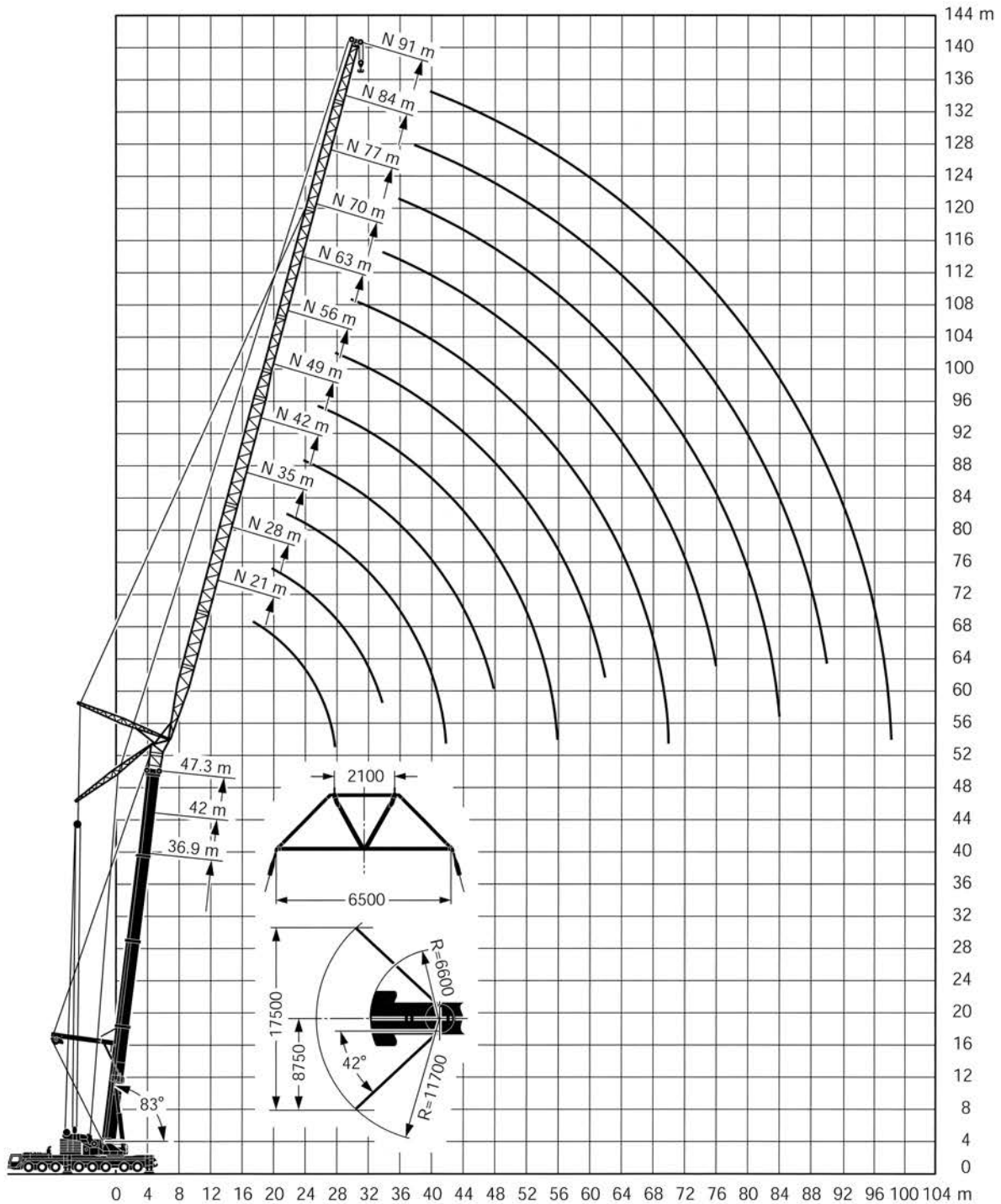

注意

- 1 定格総荷重はフックブロック、玉掛ワイヤー等の自重を含みます。
また、下記の条件が考慮されていないのでクレーンの操作には充分気をつけてください。
 - ① 地盤の強度、地震による影響
 - ② 作業速度に応じた動荷重および台風または強風による影響等
- 2 本機は水平に設置して、クレーン作業を行ってください。
- 3 作業半径は、クレーンの旋回中心から荷重の重心までの水平距離です。
- 4 メインブームの定格総荷重は補助ジブを取り除いた状態での値です。
- 5 メインブーム84m仕様で262トンを超える定格総荷重の場合は、特殊吊装置が必要です。

550t

LIEBHERR LTM1550N

オールテレーンクレーン

yonehara

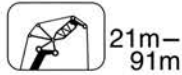

メインブーム長さ		36.9m+4m*										47.3m+4m*														
ジブ長さ		21m	28m	35m	42m	49m	56m	63m	70m	77m	84m	91m	21m	28m	35m	42m	49m	56m	63m	70m	77m	84m	91m			
16		91																								
18		84												79												
20		78	81										73	70												
22		73	76	74									67	66	60											
24		67	71	65	62	52							64	62	57	52										
26		61	62	60	60	51	40.5						60	58	55	50	44									
28			58	58	57	49.5	40	33					55	52	48	43	34.5									
30			55	55	54	48.5	39.5	32.5	26.9				52	49	46	41.5	34.5	27.8								
32			50	51	51	48	38.5	32.5	26.1	22.5			49	46.5	44.5	40	34.5	27.8								
34				48	47.5	46	38	32	25.3	22.2			46	45	42	39	34.5	27.8								
36				45	44.5	44	37.5	31.5	24.5	21.9	17.3			42.5	40.5	38	34	27.8	22.3							
38				42	41.5	41	36.5	31.5	23.8	21.6	16.8	14.6		40	39	36.5	33	27.8	22.3	17.9						
40				38.5	39.5	39	36	31	23.2	21.2	16.3	14.5		38	37.5	35	32.5	27.8	22.3	17.9	14.3					
42					37	36.5	35	30.5	22.5	20.7	15.8	14.1		35.5	35	33.5	31.5	27.4	21.8	17.9	14.3	10.9				
44					35	34.5	34	30.5	21.8	20.3	15.4	13.7			33.5	32.5	30.5	27	21.3	17.9	14.3	10.9				
46					33	33	32.5	30	21.2	19.8	15	13.3			31.5	31	29.4	26.6	20.7	17.9	14.1	10.9				
48					31	30.5	29.8	28	20.6	19.4	14.6	13			30	29.2	28.5	25.8	20.2	17.9	13.8	10.9				
50					29.7	29.2	28.7	28	20	19	14.2	12.7				27.8	27.3	24.8	19.7	17.9	13.5	10.9				
52					28.3	27.8	27.3	26.6	19.6	18.7	13.9	12.3				26.5	26	23.8	19.2	17.9	13.2	10.9				
54					24.6	26.5	26	26	19.2	18.3	13.5	12				25.2	24.8	22.9	18.8	17.8	13	10.9				
56						25.3	24.8	24.8	18.8	17.9	13.1	11.7					24.1	23.6	22.1	18.5	17.4	12.7	10.9			
58						24.2	23.7	23.7	18.4	17.6	12.8	11.4						22.6	21.2	18.1	17.1	12.5	10.9			
60						21.6	22.6	22.6	18.4	17.3	12.5	11.2						21.6	20.4	17.8	16.8	12.2	10.9			
62							21.7	21.7	17.6	17	12.2	10.9						20.7	19.7	17.5	16.4	12	10.9			
64							20.8	20.8	17.3	16.7	12	10.7							19.1	16.9	15.8	11.7	10.8			
66							19.1	19.1	17	16.4	11.7	10.5							18.4	16.3	15.3	11.5	10.7			
68							15.9	16.8	16.2	11.5	10.3								17.7	15.7	14.7	11.3	10.4			
70								16.6	15.9	11.2	10.1								16.6	15.2	14.1	11.1	10.2			
72								16.2	15.7	11	9.9									14.8	13.6	10.9	10			
74								13.8	15.5	10.8	9.8									14.5	13.2	10.7	9.6			
76									15.3	10.6	9.6									14.3	12.8	10.5	9.1			
78									14.7	10.4	9.4										12.4	10.3	8.7			
80									12.7	10.3	9.3										12.2	10.2	8.4			
82									10.5	10.1	9.1										11.9	10	8			
84										10.1	9.1										11.2	9.7	7.6			
86										10	8.9											9.4	7.3			
88											9.2											9.3	7			
90																						9.1	6.7			
92																							6.5			
94																							6.2			
96																							6.1			
98												6.4											6			
ブーム伸長率 (%)								92	46										92							
								46												92						
								0												0						
								0												0						
								0												0						

*アダプター

TAB 218256.1/2

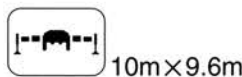
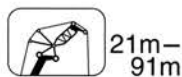

メインブーム長さ		57.7m+4m*										68.2m+4m*							78.6m+4m*							
ジブ長さ		21m	28m	35m	42m	49m	56m	63m	70m	77m	84m	21m	28m	35m	42m	49m	56m	63m	70m	21m	28m	35m	42m	49m	56m	
20		58																								
22		55																								
24		51	49.5	46.5								43.5														
26		48	46.5	44.5	39.5							41	36.5													
28		45	43.5	42.5	38							38.5	34.5													
30			41	40	36.5	32						36.5	32.5	29.9												
32			39	38	35	31	25.6					34.5	31	28.5	25.6											
34			36.5	36	34	30	25.5	19				29.5	27.1	24.4	21.3											
36			34	34	32.5	29	25.4	19.1	14.2			28.1	25.9	23.4	20.6	15.4										
38				32.5	31.5	28	25	19.2	14.3	10.8		26.7	24.7	22.4	19.8	15.6	10.5									
40				30.5	30	27.1	24.3	19.2	14.3	10.8	7.9		23.7	21.5	19	15.7	10.6									
42				28.5	28.5	26.2	23.5	19.2	14.3	10.8	8		22.7	20.6	18.2	15.3	10.6	7.2								
44				27.2	27.2	25.2	22.8	19.2	14.3	10.8	8		21.8	19.8	17.5	14.7	10.6	7.3								
46				25.8	24	22.2	20.2	14.3	10.8	8	8		20.9	19.1	16.8	14.2	10.6	7.3								
48				24.3	22.9	21.5	18.6	14.3	10.8	8	8			18.4	16.2	13.6	10.3	6.9								
50				22.5	21.9	20.8	18	14.3	10.8	8	8			17.7	15.6	13.1	9.7	6.5								
52					20.9	20	17.2	14.3	10.8	8	8			17.1	15.1	12.5	9.2	6								
54					20.1	19.2	16.4	13.8	10.8	8	8			14.6	11.9	8.7	5.6									
56					19.4	18.3	15.7	13.1	10.8	8	8			14.1	11.3	8.2	5.2									
58						17.6	15	12.5	10.8	8	8			13.6	10.7	7.7	4.8									
60						16.9	14.4	11.9	10.3	8	8			13.1	10.2	7.3	4.5									
62						16.3	13.7	11.3	9.8	7.7	7.7				9.7	6.9	4.2									
64						15.1	13.1	10.8	9.3	7.2	7.2				9.2	6.5	4									
66							12.6	10.2	8.8	6.8	6.8				8.8	6.1	3.7									

550t

LIEBHERR LTM1550N

オールテレーンクレーン yonehara



75°
36.9m-
78.6m



21m-
91m

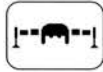

10m×9.6m



360°



165t



メインブーム長さ		36.9m+4m*										47.3m+4m*											
ジブ長さ		21m	28m	35m	42m	49m	56m	63m	70m	77m	84m	91m	21m	28m	35m	42m	49m	56m	63m	70m	77m	84m	91m
作業半径(m)		...																					
24		...																					
26		...																					
28		...																					
30		...																					
32		...																					
34		...																					
36		...																					
38		...																					
40		...																					
42		...																					
44		...																					
46		...																					
48		...																					
50		...																					
52		...																					
54		...																					
56		...																					
58		...																					
60		...																					
62		...																					
64		...																					
66		...																					
68		...																					
70		...																					
72		...																					
74		...																					
76		...																					
78		...																					
80		...																					
82		...																					
84		...																					
86		...																					
88		...																					
90		...																					
92		...																					
94		...																					
96		...																					
98		...																					
100		...																					
104		...																					
ブーム伸長率 (%)	I											
	II											
	III											
	IV											
	V											
	VI											

*アダプター

TAB 218259.1/2



75°
36.9m-
78.6m



21m-
91m



10m×9.6m



360°



165t



メインブーム長さ		57.7m+4m*										68.2m+4m*						78.6m+4m*					
ジブ長さ		21m	28m	35m	42m	49m	56m	63m	70m	77m	84m	21m	28m	35m	42m	49m	56m	63m	21m	28m	35m	42m	49m
作業半径(m)		...																					
30		...																					
32		...																					
34		...																					
36		...																					
38		...																					
40		...																					
42		...																					
44		...																					
46		...																					
48		...																					
50		...																					
52		...																					
54		...																					
56		...																					
58		...																					
60		...																					
62		...																					
64		...																					
66		...																					
68		...																					
70		...																					
72		...																					
74		...																					
76		...																					
78		...																					
80		...																					
82		...																					
84		...																					
86		...																					
88		...																					
90		...																					
92		...																					
ブーム伸長率 (%)	I					
	II					
	III					
	IV					
	V					
	VI					

*アダプター

TAB 218259.3/4

550t

LIEBHERR LTM1550N オールテレーンクレーン yonehara

67° 36.9m-78.6m
 21m-91m
 10m×9.6m
 360°
 165t
 Y-ガイ

メインブーム長さ		36.9m+4m*										47.3m+4m*											
ジブ長さ		21m	28m	35m	42m	49m	56m	63m	70m	77m	84m	91m	21m	28m	35m	42m	49m	56m	63m	70m	77m	84m	91m
作業半径(m)	32	40.5																					
	34	38																					
	36	35.5	34.5										31										
	38		32.5										29										
	40		30.5	29.7									27.3										
	42		28.8	28									26.3	26.3									
	44		26.5	25.9									24.7	24.7									
	46		25.1	24.5									23.4	22.5									
	48		23.8	23.2	22.5								22.1	21.3									
	50		22.6	22	21.3								20.9	20.1	19.6								
	52			20.9	20.2	19.7							19.1	18.5	17.5	16.6							
	54			19.9	19.2	18.7							18.1	17.2	16.6	15.7							
	56			18.9	18.3	17.7	17						17.2	16.6	15.8	14.9	14.3						
	58			18.1	17.4	16.9	16.2						15.8	15	14.1	13.6							
	60				16.6	16.0	15.4	15					15	14.3	13.4	12.8	12.1						
	62				15.8	15.3	14.6	14.2					14.3	13.6	12.7	12.2	11.5						
	64				15.1	14.6	13.9	13.5	12.8				13.6	13.0	12.1	11.6	10.9						
	66					13.9	13.3	12.9	12.2				12.1	11.5	11	10.3	9.9						
	68					13.3	12.6	12.3	11.5	10.9			11	10.4	9.7	9.4	8.9						
	70					12.7	12.1	11.7	11	10.4			10.4	9.9	9.2	8.9	8.4	8.1				8.1	
	72					12.1	11.5	11.1	10.4	9.8	9.2		9.4	8.8	8.4	7.6	7.2					7.6	
	74					11	10.6	10.1	9.3	8.7	8.2		9	8.3	7.9	7.2	6.6					6.6	
	76					10.5	10.1	9.4	8.8	8.2	7.7		8.5	7.9	7.5	6.8	6.1					6.1	
	78					10	9.6	8.9	8.3	7.7	7.2			7.5	7.1	6.4	5.7					5.7	4.8
	80						9.2	8.5	7.9	7.3	6.8			7.1	6.7	6	5.4					5.4	4.5
	82						8.8	8.1	7.5	6.9	6.4			6.7	6.4	5.6	5.1					5.1	4.3
	84						8.4	7.7	7.1	6.5	6			6	5.4	4.9	4.4					4.4	3.5
	86						8	7.3	6.7	6.1	5.6			5.7	5.1	4.6	4					4.6	3.8
	88							6.9	6.4	5.8	5.3			5.4	4.9	4.4	3.5					4.4	3.5
	90							6.6	6	5.5	5			5.2	4.6	4.2	3.3					4.2	3.3
	92							6.3	5.7	5.2	4.7			4.4	4	3.7	3.1					4.4	3.1
	94								5.4	5	4.5			4.2	4	3.7	3.1					4.2	3.1
	96								5.2	4.7	4.3			4	3.5	3.1	2.7					4	2.7
	98								5	4.5	4.1			3.3	3.3	2.5	2.3					3.3	2.3
	100								4.8	4.3	3.9			3.2	3.2	2.3	2.3					3.2	2.3
	104									3.9				2.8	2.8	2	2					2.8	2
	108													1.6	1.6								1.6
ブーム伸長率 (%)	I					92										92							
	II					46										92							
	III					46										92							
	IV					0										0							
	V					0										0							
	VI					0										0							

*アダプター

TAB 218262.1/2

67° 36.9m-78.6m
 21m-91m
 10m×9.6m
 360°
 165t
 Y-ガイ

メインブーム長さ		57.7m+4m*										68.2m+4m*					78.6m+4m*						
ジブ長さ		21m	28m	35m	42m	49m	56m	63m	70m	77m	21m	28m	35m	42m	49m	56m	21m	28m	35m				
作業半径(m)	42	22.6																					
	44	21.3																					
	46																						
	48		19.4																				
	50		17.3	16.3																			
	52		16.4	15.4																			
	54			14.6	14.1																		
	56			13.9	13.3																		
	58			13.2	12.6	11.7																	
	60				12	11.1																	
	62				11.4	10.5	9.7																
	64				10.8	9.9	9.2																
	66				10.3	9.4	8.7	6.2															
	68					8.9	8.2	5.9															
	70					8.4	7.8	5.5	3.6														
	72					8	7.4	5.2	3.3														
	74						7	4.9	3.1	1.9													
	76						6.6	4.6	2.9	1.7													
	78						6.2	4.3	2.6	1.5													
	80						6	4.1	2.4	1.3													
	82							3.9	2.2	1.1													
	84							3.6	2	1													
	86							3.4	1.8														
	88								1.6														
	90								1.5														
	92								1.3														
	94								1.2														
ブーム伸長率 (%)	I					92										92							
	II					92										92							
	III					92										92							
	IV					46										92							
	V					46										46							
	VI					0										46							

*アダプター

TAB 218262.3/4

550t

LIEBHERR LTM1550N

オールテレーンクレーン yonehara



83°
36.9m-
78.6m



21m-
91m

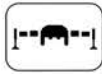

10m×9.6m



360°



165t

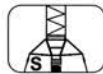

作業半径(m)	36.9m+4m*											47.3m+4m*														
	ジブ長さ											ジブ長さ														
メインブーム長さ	21m	28m	35m	42m	49m	56m	63m	70m	77m	84m	91m	21m	28m	35m	42m	49m	56m	63m	70m	77m	84m	91m				
16	90																									
18	84	81										82														
20	78	76	74									75	74													
22	72	71	69	68								69	68	67												
24	67	66	65	64	60							64	63	63	59											
26	60	62	61	60	54	46						60	58	58	56											
28		58	58	57	54	45	39					57	54	54	53	49	41.5									
30		54	54	54	52	44	39	29.4					51	50	50	47	40.5	34.5								
32			50	51	50	49	43	38.5	28.4	26			48.5	47	47	45.5	40	34								
34			47.5	47	46.5	41.5	38	27.4	25.5				46	45	44	43.5	39.5	33.5	26.6							
36			45	44	43.5	40.5	37	26.5	24.7	19				42	41.5	41	38	33	25.7	22.7						
38			42	41.5	41	39.5	36.5	25.6	23.9	18.3	15.5			39.5	39	38.5	36.5	32.5	25	22.6	17.9					
40				38.5	39	38.5	38	36	24.8	23.2	17.7	15.1			37.5	37	36	35	32	24.2	22.6	17.3	14.3			
42					37	36	35.5	35	24	22.6	17.1	14.7			35.5	35	34	33	30.5	23.6	22.3	16.8	14.1			
44					35	34.5	34	33.5	23.2	22	16.6	14.3				33	32.5	31.5	29	22.9	22	16.3	13.8			
46					32.5	32.5	32	31.5	22.5	21.4	16.1	13.9				31	30.5	30	27.6	22.3	21.4	15.8	13.4			
48					31	30.5	30	21.8	20.8	15.6	13.5				29.6	29	28.6	26.3	21.7	20.8	15.4	13.1				
50					29.4	28.9	28.6	21.2	20.3	15.1	13.2					27.6	27.1	25.2	21.1	20.2	14.9	12.8				
52					28	27.5	27.2	20.6	19.8	14.6	12.9						26.3	25.8	24.1	20.6	19.7	14.5	12.5			
54					26.2	25.9	25.9	20.1	19.3	14.2	12.6							24.6	23.2	20.1	19.2	14.1	12.2			
56					24.6			25	24.7	19.6	18.4	12.2						23.9	23.5	22.3	19.6	18.7	13.7	11.9		
58								23.9	23.6	19.2	18.4	11.9							22.4	21.4	19.2	18.1	13.3	11.6		
60								21.5	22.5	18.7	18	11.6							21.4	20.5	18.5	17.4	13	11.4		
62									21.6	18.3	17.7	12.7	11.4						20.5	19.8	17.8	16.7	12.6	11.1		
64									20.7	17.9	17.3	12.4	11.1							19.1	17.1	16.1	12.3	10.9		
66									18.8	17.5	17	12.1	10.9							18.3	16.4	15.4	12.1	10.6		
68									15.6	17.2	16.6	11.9	10.7							17.5	15.8	14.8	11.8	10.4		
70										16.9	16.3	11.6	10.4							16.6	15.3	14.2	11.6	10.2		
72										16.4	16	11.3	10.2								14.9	13.7	11.3	9.9		
74										13.8	15.8	11	10								14.6	13.2	11.1	9.5		
76											15.2	10.8	9.8								14.3	13.2	11.1	9.5		
78												14.6	10.6	9.6								12.4	10.6	8.6		
80												12.7	10.4	9.5								12.2	10.3	8.2		
82												10.5	10.2	9.3								11.9	10	7.8		
84													10.1	9.1								11.2	10	7.4		
86														9.2									9.5	7.4		
88																							9.3	6.8		
90																							9.1	6.5		
92																								8.7	6.2	
94																								8	6	
96																									6.4	5.9
98																										5.8

*アダプター

TAB 231403.1/2



83°
36.9m-
78.6m



21m-
91m

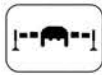

10m×9.6m



360°



165t



作業半径(m)	57.7m+4m*											68.2m+4m*							78.6m+4m*								
	ジブ長さ											ジブ長さ							ジブ長さ								
メインブーム長さ	21m	28m	35m	42m	49m	56m	63m	70m	77m	84m	21m	28m	35m	42m	49m	56m	63m	70m	21m	28m	35m	42m	49m	56m			
20	58										44.5																
22	54	52									41.5	37.5															
24	51	49	47.5								38.5	35	33.5									27.6					
26	47.5	46	44.5	43.5							36.5	33	31.5									25.6	20.7				
28		44.5	43.5	42	41						34.5	31	29.6	27.8								23.7	20.7				
30		41	39.5	38.5	36.5							29.6	26.3	24.2								22.2	19.5	17.4			
32		38.5	37.5	36.5	34.5	32						27.9	26.3	24.2								18.3	16.3	14.8			
34		36.5	35.5	35	33	30.5	27.2					27.8	26.3	24.9	23	19.9						17.2	15.3	13.8			
36		33.5	34	33	31.5	29.3	26	22.3				26.4	24.9	23.5	21.8	18.7	14.6					16.2	14.4	13	10.3		
38			32	31.5	29.6	28	24.9	21.5	17				23.7	22.3	20.7	17.6	13.6					15.3	13.6	12.2	9.6	4.3	
40			30.5	29.8	27.9	26.8	23.9	20.4	17	12.9			22.6	21.1	19.6	16.6	12.8			8.4			12.8	11.5	9	4	
42			28.5	28.3	26.4	25.5	22.7	19.5	16.8	12.9			21.6	20.1	18.6	15.6	12			7.8			12.1	10.8	8.3	3.6	
44				27	25.1	24.2	21.5	18.5	16	12.9			20.7	19.2	17.7	14.7	11.3			7.3			11.5	10.1	7.7	3.3	
46				25.6	24	22.9	20.3	17.4	15.3	12.6				18.4	16.9	13.8	10.6			6.8			9.6	7.1	3.1		
48				24.2	22.9	21.8	19.2	16.5	14.4	11.9				17.6	16.1	13	10			6.3			9	6.6	2.8		
50				22.4	21.8	20.8	18.1	15.5	13.6	11.2				16.8	15.4	12.2	9.3			5.9			8.5	6.1	2.5		
52					20.8	19.8	17.2	14.7	12.8	10.5					14.7	11.6	8.7	5.4			5.4			8	5.7	2.3	
54					20	18.9	16.4	13.8	12.1	9.9					14	10.9	8.2	5			5.3				5.3	2.1	
56					19.2	18.1	15.7	13	11.3	9.3					13.3	10.4	7.6	4.6			4.9				4.9	1.8	
58					17.3	15	12.4	10.6	8.7						12.8	9.8	7.1	4.3			4.7				4.7	1.6	
60					16.6	14.3	11.8	10	8.1							9.3	6.6	4			4.7				4.6	1.4	
62					16	13.6	11.2	9.4	7.6							8.8	6.1	3.7			4.7				4.6	1.2	
64					14.9	13	10.6	8.9	7.1							8.4	5.6	3.4			4.7				4.6	1.1	
66						12.5	10	8.4	6.6								5.2	3.2			4.9					4.4	
68						12	9.5	7.9	6.3								4.9	2.9			4.7					4.3	
70						11.6	9	7.4	5.9								4.7	2.7			4.7					4.3	
72							8.6	6.																			

550t

LIEBHERR LTM1550N

オールテレーンクレーン yonehara



67°
36.9m-
78.6m



21m-
91m

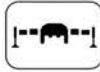

10m×9.6m



360°



165t

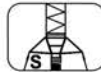

メインブーム長さ ジブ長さ	36.9m+4m*											47.3m+4m*										
	21m	28m	35m	42m	49m	56m	63m	70m	77m	84m	91m	21m	28m	35m	42m	49m	56m	63m	70m	77m	84m	91m
32	39.5																					
34	37																					
36	34.5											29.7										
38		34										27.9										
40		31.5										26.3										
42		29.9	29									25.4										
44		28.2	27.4									24										
46		26.7	25.9	25								22.6	21.6									
48			23.7	23.7								21.4	20.4									
50			23.2	22.4	21.7							20.2	19.2	18.6								
52			22	21.3	20.5							18.2	17.6									
54				20.2	19.5	18.9						17.3	16.6	16								
56				19.2	18.5	17.9						16.4	15.8	15.1								
58				18.3	17.6	17	16.5					15	14.3	13.7								
60				17.4	16.7	16.2	15.7					14.2	13.5	13								
62					15.9	15.4	14.9	14.3				13.5	12.8	12.3	11.5							
64					15.2	14.6	14.2	13.5				12.9	12.2	11.6	10.9							
66						14.5	13.9	13.5	12.9	12.4												
68							13.3	12.9	12.2	11.7												
70								12.7	12.2	11.6	11.1											
72								12.1	11.7	11	10.5	10										
74								11.6	11.1	10.5	10	10.6	10.5									
76									10.6	10	9.5	9	8.4	7.8								
78										9.7	9.1	8.6	8	7.4								
80											8.6	8.1	7.6	6.9								
82											8.2	7.7	7.1	6.5								
84											7.8	7.3	6.8	6.2								
86											7.5	7	6.4	5.8								
88												6.6	6	5.5								
90												6.3	5.7	5.2								
92													5.4	5								
94													5.2	4.7								
96														4.5	4.5							
98														4.8	4.3							
100															4.5	4.1						
104																4.1						
108																	3.7					
ブーム伸長率 (%)	I																					
	II																					
	III																					
	IV																					
	V																					
	VI																					

*アダプター

TAB 231409.1/2



67°
36.9m-
78.6m



21m-
91m



10m×9.6m



360°



165t



メインブーム長さ ジブ長さ	57.7m+4m*											68.2m+4m*					78.6m+4m*		
	21m	28m	35m	42m	49m	56m	63m	70m	77m										
42	21.7																		
44	20.5																		
46		18.3																	
48		17.3																	
50		16.4	15.6																
52		15.5	14.7																
54			13.9	13.1															
56			13.2	12.4															
58			12.5	11.7															
60				11.1	10.4														
62				10.5	9.9	8.9													
64				10	9.3	8.3													
66				9.5	8.8	7.8	5.6												
68					8.4	7.4	5.3												
70					7.9	6.9	4.9	3											
72					7.5	6.5	4.6	2.8											
74						6.1	4.3	2.6	1.4										
76						5.8	4	2.3	1.3										
78						5.4	3.8	2.1	1.1										
80						5.2	3.6	1.9	1										
82							3.4	1.8											
84							3.2	1.6											
86							3	1.4											
88								1.2											
90								1											
ブーム伸長率 (%)	I																		
	II																		
	III																		
	IV																		
	V																		
	VI																		

*アダプター

TAB 231409.3/4

550t

LIEBHERR LTM1550N

オールテレーンクレーン yonehara



メインブーム長さ		47.3m+2.2m*						57.7m+2.2m*							
ジブ長さ		14m	21m	28m	35m	42m	49m	56m	14m	21m	28m	35m	42m	49m	56m
12	48	35.5							36	29.3					
14	44	32.5	25.4	19.9					33	27.3					
16	41	29.9	23.4	18.3	13.3				28	24.2	21.2				
18	38	27.7	21.7	17	12.3	11.2	8.8		30.5	25.6	19.9	15.4	11.7		
20	35.5	25.8	20.2	15.8	11.4	10.3	8		28	24.2	18.7	14.5	11	9.2	
22	33	24	18.8	14.7	10.6	9.6	7.4		25.9	22.6	17.7	13.6	10.3	8.6	6.5
24	31	22.5	17.6	13.7	9.9	8.9	6.9		24	21.1	16.8	12.9	9.7	8.1	6.2
26	29.4	21.2	16.4	12.8	9.3	8.3	6.3		22.2	19.6	15.9	12.2	9.2	7.6	5.6
28	27.4	20.1	15.5	12	8.7	7.8	5.9		20.6	18.2	15.1	11.5	8.7	7.1	5.2
30	25.3	19.1	14.7	11.3	8.1	7.2	5.4		19.1	16.9	14.3	10.9	8.2	6.7	4.9
32	23.4	18.1	13.9	10.7	7.6	6.7	5		17.8	15.7	13.6	10.4	7.8	6.3	4.5
34	21.6	17.2	13.2	10.1	7.2	6.3	4.6		16.6	14.6	12.9	9.8	7.4	5.9	4.2
36	19.9	16.3	12.6	9.6	6.8	5.9	4.2		15.4	13.6	12.1	9.4	7	5.5	3.9
38	18.1	15.3	12	9.1	6.4	5.5	3.9		14.4	12.7	11.3	8.9	6.6	5.2	3.6
40	16.4	14.5	11.3	8.7	6.1	5.2	3.6		13.3	11.8	10.5	8.5	6.3	4.9	3.4
42	14.7	13.6	10.7	8.2	5.8	4.9	3.3		12.4	11	9.8	8.1	6	4.6	3.1
44	13.3	12.8	10	7.8	5.5	4.5	3.1		11.4	10.2	9.1	7.8	5.7	4.4	2.9
46	12.2	12	9.4	7.4	5.2	4.3	2.8		10.3	9.5	8.5	7.3	5.5	4.1	2.6
48	11.1	10.9	8.8	7	4.9	4	2.6		9.3	8.7	7.8	6.8	5.2	3.8	2.4
50	10.2	10	8.3	6.5	4.6	3.7	2.4		8.3	8	7.2	6.3	5	3.6	
52	9.2	9.2	7.7	6.1	4.4	3.5			7.4	7.2	6.7	5.8	4.7	3.4	
54	8.3	8.4	7.2	5.7	4.1	3.3			6.7	6.5	6.1	5.3	4.4	3.2	
56	7.5	7.7	6.9	5.3	3.9	3			6.1	5.7	5.6	4.9	4	3	
58	6.9		6.6	4.9	3.6	2.8			5.5	5.1		4.4	3.7	2.8	
60	6.3		6.2	4.7	3.4	2.6			4.9	4.5		4.4	4	3.3	2.6
62			5.6	4.5	3.1	2.4			4.3	4		3.8	3.6	3	2.3
64			5.1	4.3	2.9	2.2			3.7	3.5		3.3	3.1	2.7	2
66			4.7	4.1	2.8	2			3.1	3		2.9	2.6	2.4	
68				4.2	3.9	2.6	1.8		2.7	2.5		2.4	2.2	2	
70				3.8	3.7	1.9				2.1		2	1.9		
72				3.4	3.3					1.6			1.7		
74					2.8										
76					2.5										
78					2.1										
ブーム伸長率 (%)	I				92										92
	II				92										92
	III				92										92
	IV				0										46
	V				0										46
	VI				0										0

*アダプター

TAB 218316



メインブーム長さ		68.2m+2.2m*						78.6m+2.2m*						
ジブ長さ		14m	21m	28m	35m	42m	49m	56m	14m	21m	28m	35m	42m	
16	24.5													
18	22.7	19.3	16.3						16.3					
20	21	17.9	15.1	12.9					15.1	12.6				
22	19.5	16.8	14.1	12.1	8.7				14.1	11.7	9.8			
24	18.2	15.7	13.2	11.3	8.3	6.7	4.8		13.1	10.9	9.1	7.6		
26	16.8	14.6	12.4	10.6	7.9	6.3	4.5		12.3	10.3	8.5	7	5.2	
28	15.7	13.7	11.7	10	7.5	5.9	4.2		11.6	9.6	7.9	6.5	4.8	
30	14.6	12.8	10.9	9.4	7.1	5.6	3.9		10.8	9	7.4	6	4.4	
32	13.4	11.9	10.2	8.8	6.7	5.3	3.6		10.1	8.5	6.9	5.6	4.1	
34	12.4	10.9	9.5	8.3	6.3	5.1	3.4		9.4	7.9	6.5	5.2	3.8	
36	11.5	10.1	8.7	7.8	6.6	5.4	3.2		8.6	7.4	6	4.8	3.5	
38	10.6	9.3	8	7.2	6.6	5.2	4.3		7.9	6.9	5.6	4.5	3.2	
40	9.8	8.6	7.4	6.6	6.2	5.2	4.3		7.2	6.3	5.2	4.1	2.9	
42	9.1	7.9	6.7	6.1	4.8	4	2.8		6.6	5.7	4.7	3.8	2.6	
44	8.4	7.2	6.2	5.5	4.4	3.7			6	5.2	4.3	3.4		
46	7.7	6.6	5.6	5	3.9	3.3			5.4	4.7	3.8	3.1		
48	7	6	5.1	4.6	3.5	2.9			4.9	4.2	3.4	2.7		
50	6.4	5.4	4.6	4.1	3.2	2.5			4.4	3.8	3	2.3		
52	5.8	4.9	4.1	3.7	2.8				3.9	3.3	2.6			
54	5.2	4.4	3.6	3.3	2.5				3.4	2.9	2.2			
56	4.6	3.9	3.2	2.9	2.1				2.9	2.5				
58	4.1	3.4	2.7	2.5					2.5	2.1				
60	3.5	3	2.3	2.1					2.1					
62	3	2.6	2											
64	2.6	2.2												
66	2.1													
ブーム伸長率 (%)	I				92									92
	II				92									92
	III				92									92
	IV				92									92
	V				46									92
	VI				46									92

*アダプター

TAB 218316

550t

LIEBHERR LTM1550N

オールテレーンクレーン **yonehara**

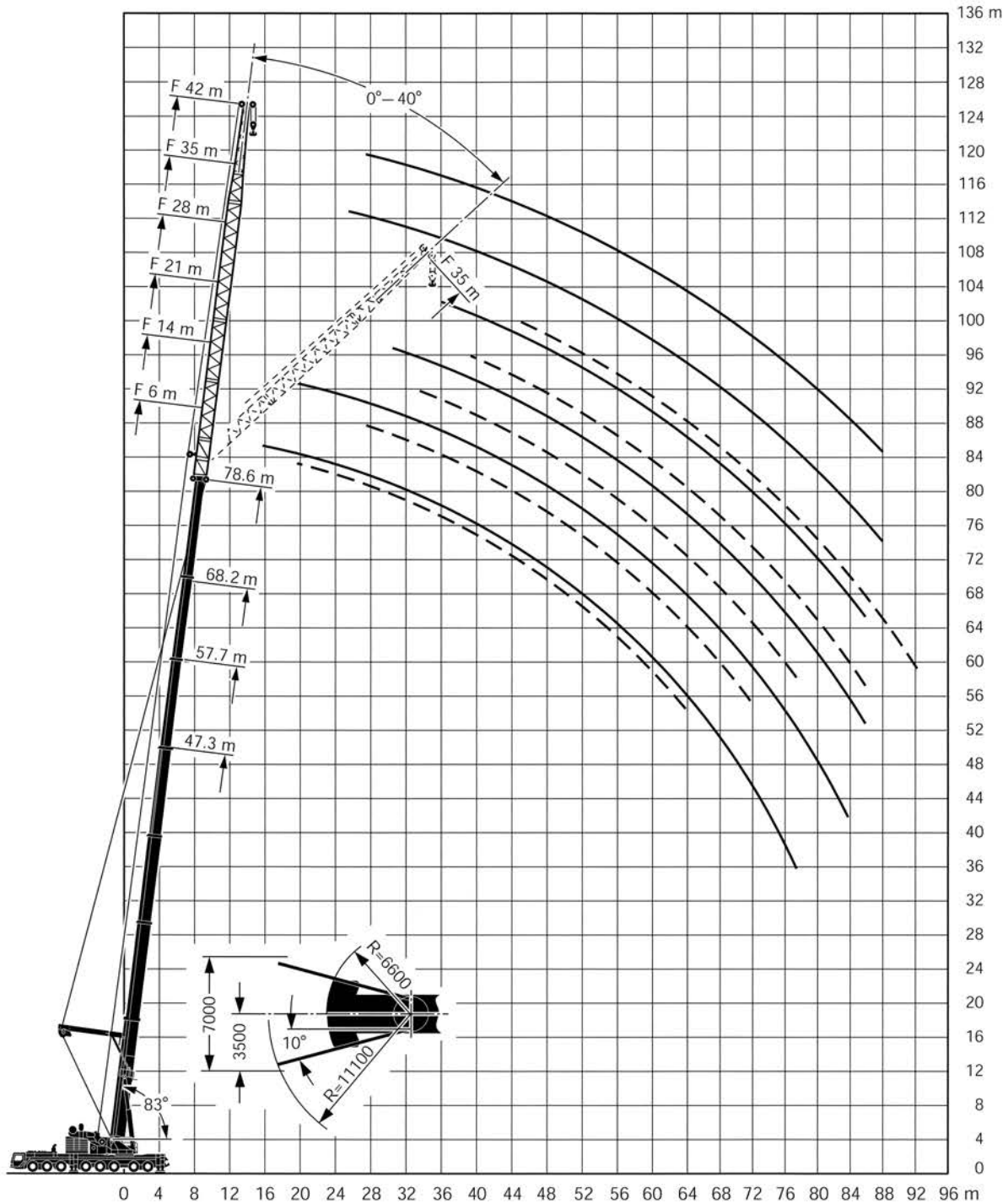

注意

- 1 定格総荷重はフックブロック、玉掛ワイヤー等の自重を含みます。
また、下記の条件が考慮されていないのでクレーンの操作には充分気をつけてください。
 - ① 地盤の強度、地震による影響
 - ② 作業速度に応じた動荷重および台風または強風による影響等
- 2 本機は水平に設置して、クレーン作業を行ってください。
- 3 作業半径は、クレーンの旋回中心から荷重の重心までの水平距離です。
- 4 メインブームの定格総荷重は補助ジブを取り除いた状態での値です。
- 5 メインブーム84m仕様で262トンを超える定格総荷重の場合は、特殊吊装置が必要です。

550t

LIEBHERR LTM1550N

オールテレーンクレーン yonehara



メインブーム長さ ジブ長さ		47.3m+2.2m*						57.7m+2.2m*					
作業半径(m)	6m	14m	21m	28m	35m	42m	6m	14m	21m	28m	35m	42m	
12	72												
14	67												
16	63	33					68						
18	59	32	20.2	13.2			64						
20	55	31	19.4	12.7			61	34					
22	52	30	18.7	12.2			58	33					
24	49	29.2	18.1	11.8			55	32	19.9				
26	46.5	28.5	17.5	11.4	8.8		51	31.5	19.4				
28	44	27.9	17	11	8.4		47	31	18.8	13.1			
30	41	27.3	16.5	10.6	8.1	6.1	43.5	30.5	18.4	12.7			
32	38.5	26.8	16.1	10.3	7.8	5.8	40.5	29.8	18	12.3	8.9		
34	33	26.3	15.8	10.1	7.5	5.6	37.5	29.2	17.6	12	8.6	6	
36	29.3	25.9	15.4	9.8	7.2	5.4	34	28.7	17.2	11.6	8.3	5.7	
38	26.1	25.5	15.1	9.6	6.9	5.2	31	28.3	16.9	11.3	8	5.6	
40	23.3	25.2	14.8	9.4	6.7	5	27.9	27.8	16.6	11.1	7.8	5.4	
42	20.7	24.1	14.5	9.1	6.5	4.8	25.1	26.4	16.3	10.8	7.6	5.2	
44	18.4	21.7	14.3	8.9	6.3	4.6	22.6	24.6	16.1	10.6	7.4	5	
46	16.3	19.4	14.1	8.8	6.1	4.5	20.2	22.7	15.9	10.4	7.2	4.9	
48	14.3	17.4	14	8.7	6	4.3	18.1	20.6	15.6	10.2	7	4.7	
50		15.5	13.9	8.6	5.8	4.2	16.2	18.6	15.4	10.1	6.9	4.6	
52		13.8	13.7	8.6	5.7	4.1	14.4	16.7	15.3	9.9	6.7	4.5	
54		12.2	13.6	8.5	5.5	4	12.8	15	15.1	9.7	6.6	4.4	
56		10.7	13	8.4	5.5	3.9	11.2	13.4	15	9.6	6.5	4.3	
58			11.6	8.4	5.4	3.8	9.8	12.3	13.7	9.5	6.3	4.2	
60			10.2	8.3	5.4	3.7	8.5	10.6	12.3	9.4	6.2	4.1	
62			8.9	8.2	5.3	3.6		9.3	11	9.3	6.1	4	
64			7.5	8.2	5.3	3.6		8.1	9.8	9.3	6	3.9	
66				7.3	5.3	3.6		7	8.6	9.2	6	3.8	
68				6.3	5.2	3.5		5.9	7.6	9	5.9	3.8	
70					5.2	3.5			6.5	7.9	5.9	3.8	
72					5.2	3.4			5.5	6.9	5.8	3.7	
74					5.1	3.4			4.8	6	5.8	3.7	
76					5.1	3.3			3.4	5.2	5.7	3.7	
78					4.4	3.3				4.5	5.6	3.6	
80						3.3				3.8	4.9	3.6	
82						3.3				3	4.3	3.6	
84						3.3					3.7	3.6	
86						3.3					3	3.6	
88											2.2	3.3	
90												2.6	
92												1.9	
ブーム 伸長率 (%)	I			92						92			
	II			92						92			
	III			92						92			
	IV			0						46			
	V			0						46			
	VI			0						0			

*アダプター

TAB 218495

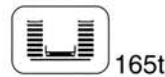
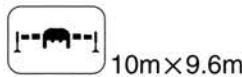

メインブーム長さ ジブ長さ		68.2m+2.2m*						78.6m+2.2m*					
作業半径(m)	6m	14m	21m	28m	35m	42m	6m	14m	21m	28m	35m	42m	
16	55												
18	52						38.5						
20	49	33.5					37						
22	46.5	31.5					35						
24	44	30.5	20.4				33.5	25.1					
26	41	29.5	20				32.5	24.2					
28	38.5	29.5	19.6	12.8			31	23.4	17.4				
30	36	28.7	19.2	12.5			29.6	22.6	16.9				
32	34	27.9	18.8	12.2			28.3	21.9	16.4				
34	31.5	27.2	18.5	11.9	8.4		26.9	21.2	15.9	11.9			
36	29.8	26.5	18.2	11.7	8.2	5.5	25.7	20.6	15.5	11.6			
38	28	25	17.9	11.4	7.9	5.3	24.4	20	15.1	11.2	7.8		
40	25.8	23.5	17.6	11.2	7.8	5.2	23.1	19.4	14.7	10.9	7.7		
42	23.6	22.2	17.3	11	7.6	5	21.8	18.8	14.3	10.6	7.5	5.4	
44	21.5	20.9	16.9	10.8	7.4	4.9	20.6	18.2	13.9	10.3	7.4	5.3	
46	19.6	19.7	16.5	10.7	7.2	4.8	19.4	17.4	13.5	10	7.2	5.2	
48	17.7	18.6	16.2	10.5	7.1	4.7	18.3	16.5	13.1	9.7	7.1	5.1	
50	15.9	17.4	15.9	10.4	7	4.6	16.9	15.6	12.8	9.4	7	5	
52	14.3	16	15.6	10.3	6.9	4.5	15.4	14.8	12.4	9.1	6.9	4.9	
54	12.8	14.5	14.7	10.2	6.8	4.4	14.1	14	12.1	8.9	6.6	4.8	
56	11.3	13.1	13.9	10.1	6.6	4.3	12.8	13.2	11.7	8.6	6.4	4.7	
58	10	11.7	13.1	9.9	6.6	4.3	11.5	12.6	11.4	8.4	6.3	4.7	
60	8.8	10.5	11.9	9.8	6.5	4.2	10.3	11.5	11	8.2	6.1	4.6	
62	7.7	9.3	10.7	9.7	6.4	4.2	9.1	10.4	10.6	8	5.9	4.5	
64	6.6	8.2	9.5	9.7	6.3	4.1	8.1	9.3	10	7.8	5.7	4.5	
66	5.6	7.1	8.5	9.6	6.2	4	7.1	8.3	9.3	7.6	5.6	4.4	
68	4.5	6.1	7.4	9.6	6.1	4	6.1	7.3	8.4	7.3	5.4	4.2	
70		5.3	6.5	7.7	6.1	3.9	5.3	6.4	7.5	7.1	5.3	4.1	
72		4.6	5.6	6.7	6.1	3.9	4.6	5.5	6.6	6.9	5.2	4	
74		3.9	4.9	5.9	6.1	3.8	4	4.8	5.7	6.5	5	3.8	
76		3	4.2	5.1	6	3.8	3.3	4.2	5	5.6	4.9	3.7	
78			3.6	4.5	5.3	3.8	2.4	3.6	4.4	5	4.8	3.5	
80			2.8	3.9	4.7	3.8		2.9	3.8	4.4	4.6	3.4	
82			2	3.3	4.1	3.8		2.2	3.7	4.3	4.3	3.3	
84				2.5	3.4	3.8		1.5	3.1	3.7	3.7	3.1	
86				1.8	2.8	3.4			2.5	3.1	3.1	3	
88					2.2	2.8			1.9	2.5	2.5	2.9	
90					1.5	2.2				2	2.6	2.6	
92						1.6				1.3	1.4	2.1	
94												1.6	
ブーム 伸長率 (%)	I			92						92			
	II			92						92			
	III			92						92			
	IV			92						92			
	V			46						92			
	VI			46						92			

*アダプター

TAB 218495

550t

LIEBHERR LTM1550N

オールテレーンクレーン

yonehara



47.3m-
78.6m



40°
6m-
35m

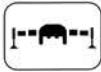

10m×9.6m



360°



165t



メインブーム長さ		47.3m+2.2m*					57.7m+2.2m*				
ジブ長さ		6m	14m	21m	28m	35m	6m	14m	21m	28m	35m
作業半径(m)											
12		43									
14		41					42				
16		39.5					40.5				
18		38					39.5				
20		37	20.6				38				
22		36	20.5				37	21.3			
24		34.5	20.3	11.7			36	21.3			
26		34	20.2	11.5			35	21.2			
28		33	20.2	11.4			34.5	21.2	12		
30		32	20.1	11.3	7		33.5	21.2	11.9		
32		31.5	20.1	11.2	6.9		33	21.2	11.9	7.3	
34		30.5	20.1	11.2	6.8		32.5	21.2	11.8	7.3	
36		31.5	20.1	11.1	6.8	4.3	31.5	21.2	11.8	7.2	
38		30.5	20.1	11.1	6.7	4.3	28.6	21.2	11.8	7.2	4.6
40		29.9	20.1	11.1	6.6	4.3	25.7	21.2	11.8	7.1	4.6
42		26.7	20.1	11.1	6.6	4.3	23.1	21.2	11.8	7.1	4.5
44		23.7	20.1	11.1	6.6	4.1	20.7	21.2	11.8	7.1	4.5
46			20.1	11.1	6.6	4.1	18.5	21.2	11.8	7.1	4.5
48			18.2	11.1	6.6	4.1	16.5	19.6	11.8	7.1	4.4
50				11.1	6.6	4		17.6	11.8	7.1	4.4
52				11.1	6.6	4		15.8	11.8	7.1	4.4
54				11.1	6.6	4		14.1	11.8	7.1	4.4
56				11.1	6.6	4		12.6	11.8	7.1	4.4
58					6.6	4			11.8	7.1	4.4
60					6.6	4			11.8	7.1	4.4
62					6.6	4			10.6	7.1	4.4
64						4			9.3	7.1	4.4
66						4				7.1	4.4
68						4				7.1	4.4
70						4				7.1	4.4
72										7.1	4.4
74											4.4
76											4.4
ブーム伸長率(%)	I			92					92		
	II			92					92		
	III			92					92		
	IV			0					46		
	V			0					46		
	VI			0					0		

*アダプター

TAB 218497



47.3m-
78.6m



40°
6m-
35m

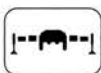

10m×9.6m

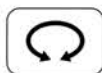

360°



165t



メインブーム長さ		68.2m+2.2m*					78.6m+2.2m*				
ジブ長さ		6m	14m	21m	28m	35m	6m	14m	21m	28m	35m
作業半径(m)											
18		40									
20		49					36				
22		48					34.5				
24		47	22.2				33.5				
26		46	22.2				32				
28		45.5	22.2				31	20.7			
30		34.5	22.2	12.6			29.6	20.1			
32		33.5	22.2	12.5			28.2	19.6			
34		31.5	22.2	12.5			26.9	19.1	12.9		
36		29.5	22.2	12.5	7.2		25.7	18.7	12.9		
38		27.8	22.2	12.5	7.2		24.2	18.2	12.8		
40		26.2	21.8	12.5	7.2		23	17.8	12.6		
42		24.2	21.5	12.5	7.2	4.5	21.7	17.5	12.3	7.4	
44		22	21	12.5	7.2	4.5	20.6	17.1	12.1	7.4	
46		20.1	19.8	12.5	7.2	4.5	19.5	16.6	11.8	7.4	4.4
48		18.1	18.7	12.5	7.2	4.5	18.5	16.2	11.6	7.4	4.4
50		16.3	17.6	12.5	7.2	4.5	17.4	15.7	11.3	7.4	4.4
52		14.6	16.6	12.5	7.2	4.4	15.9	15	11.1	7.4	4.4
54		13	15.4	12.5	7.2	4.4	14.5	14.2	10.9	7.4	4.4
56		11.6	13.9	12.5	7.2	4.4	13.1	13.5	10.7	7.4	4.4
58			12.4	12.5	7.2	4.4	11.8	12.8	10.6	7.3	4.4
60			11.1	12.5	7.2	4.4	10.5	12.1	10.4	7.2	4.4
62			9.8	11.7	7.2	4.4	9.3	11.1	10.2	7.1	4.4
64			8.6	10.5	7.2	4.4	8.3	9.9	10	6.9	4.4
66				9.3	7.2	4.4		8.8	9.6	6.8	4.4
68				8.2	7.2	4.4		7.8	9.1	6.7	4.4
70				7.2	7.2	4.4		6.8	8.3	6.6	4.4
72				7.2	7.2	4.4		5.9	7.3	6.5	4.4
74					6.8	4.4			6.4	6.4	4.4
76					5.9	4.4			5.5	6.3	4.4
78					5.1	4.4			4.9	5.8	4.4
80						4.4				5.1	4.3
82						4.4				4.5	4.2
84						4.2				3.8	4.1
86										3.1	4
88											3.5
90											2.8
92											2.2
ブーム伸長率(%)	I			92					92		
	II			92					92		
	III			92					92		
	IV			92					92		
	V			46					92		
	VI			46					92		

*アダプター

TAB 218497

550t

LIEBHERR LTM1550N

オールテレーンクレーン **yonehara**

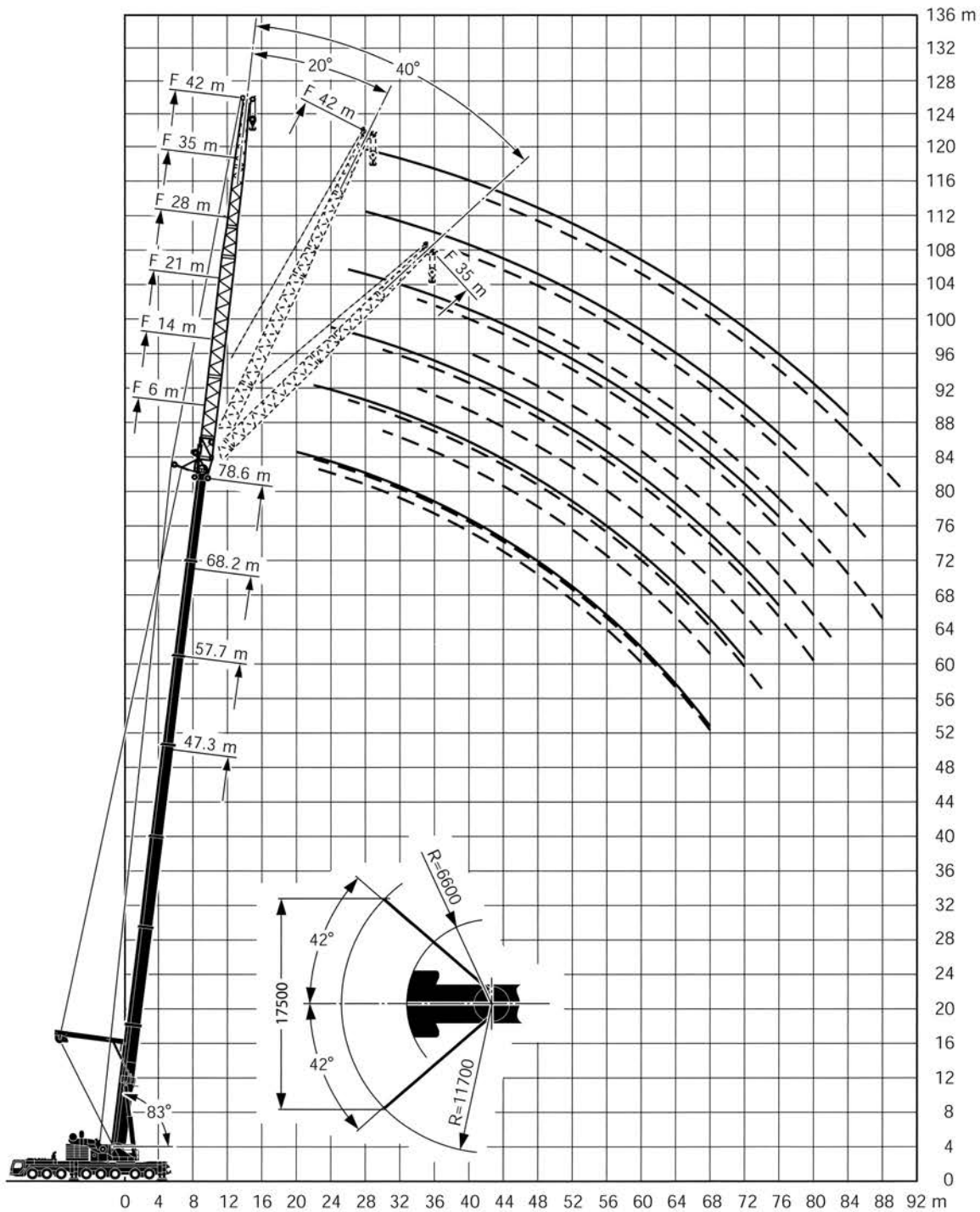

注意

- 1 定格総荷重はフックブロック、玉掛ワイヤー等の自重を含みます。
また、下記の条件が考慮されていないのでクレーンの操作には充分気をつけてください。
 - ① 地盤の強度、地震による影響
 - ② 作業速度に応じた動荷重および台風または強風による影響等
- 2 本機は水平に設置して、クレーン作業を行ってください。
- 3 作業半径は、クレーンの旋回中心から荷重の重心までの水平距離です。
- 4 メインブームの定格総荷重は補助ジブを取り除いた状態での値です。
- 5 メインブーム84m仕様で262トンを超える定格総荷重の場合は、特殊吊装置が必要です。

550t

LIEBHERR LTM1550N

オールテレーンクレーン **yonehara**



47.3m-78.6m



0°
6m-56m



10m×9.6m



360°



165t



作業半径(m)	47.3m+2.2m*								57.7m+2.2m*							
	6m	14m	21m	28m	35m	42m	49m	56m	6m	14m	21m	28m	35m	42m	49m	56m
9	102															
10	100															
12	96	81	59						90							
14	92	76	55	41.5					85	74						
16	82	71	51	39	31.5	26			76	70	51	39				
18	73	67	48	36.5	29.4	24.4	19.6		68	65	48.5	37	28.6	23.7		
20	66	63	45.5	34.5	27.7	23.7	18.4	14.9	62	59	46.5	35	27.1	22.4	17.8	
22	60	58	43	32.5	26	21.7	17.4	14.1	56	54	43.5	33	25.8	21.3	16.9	13.7
24	55	53	40.5	30.5	24.7	20.5	16.5	13.3	51	49	41.5	31.5	24.6	20.3	16.1	13.7
26	49.5	48.5	38.5	29.1	23.4	19.5	15.5	12.6	47	45	40	30	23.4	19.3	15.4	13.2
28	44	45	37	27.8	22.1	18.5	14.8	11.9	43	41.5	38	28.9	22.4	18.4	14.6	12.6
30	39	40.5	35	26.5	21.2	17.5	14.1	11.3	39.5	38.5	36.5	27.5	21.4	17.6	13.9	12
32	35	37	33.5	25.2	20.2	16.7	13.3	10.7	36	35.5	34.5	26.5	20.4	16.9	13.3	11.4
34	31	33.5	32	24	19.3	16	12.7	10.1	32	32.5	33	25.5	19.6	16.1	12.8	10.9
36	27.7	30	30.5	23	18.4	15.2	12.1	9.6	29.2	29.8	29.9	24.5	18.9	15.4	12.2	10.4
38	24.6	26.9	28.4	22.1	17.6	14.5	11.6	9.1	26.3	27.1	27.5	23.5	18.2	14.9	11.6	10
40	21.9	24.2	25.9	21.1	16.9	13.8	11.1	8.7	23.6	24.7	25.1	22.6	17.5	14.3	11.2	9.5
42	19.4	21.7	23.4	20.2	16.2	13.3	10.5	8.3	21.1	22.4	23	21.9	16.8	13.7	10.8	9.1
44	17.2	19.4	21.1	19.4	15.5	12.8	10	7.9	18.9	20.4	21	21.2	16.2	13.2	10.3	8.7
46	15.1	17.4	19.1	18.7	14.8	12.3	9.6	7.5	16.8	18.3	19.2	19.6	15.6	12.6	9.9	8.4
48	13.3	15.5	17.2	17.9	14.3	11.7	9.2	7.1	15	16.5	17.5	17.9	15.1	12.2	9.5	7.8
50	11.1	13.8	15.5	16.7	13.7	11.2	8.8	6.8	13.2	14.7	15.9	16.4	14.6	11.8	9.1	7.7
52		12.2	13.9	15.1	13.2	10.8	8.4	6.5	11.3	13.2	14.3	15	14.1	11.4	8.8	7.3
54		10.7	12.4	13.6	12.6	10.3	8	6.2	9.7	11.7	12.8	13.6	13.6	11	8.5	7
56		9.4	11	12.2	12	9.9	7.7	5.8	8.7	10.3	11.5	12.4	13	10.6	8.2	6.7
58		7.1	9.7	10.9	11.6	9.4	7.3	5.5	6.5	9.1	10.2	11.1	11.9	10.2	7.9	6.5
60			8.6	9.8	10.9	9	7	5.2	4.9	9	9.9	10.8	10.8	9.8	7.6	6.2
62			7.4	8.6	9.8	8.5	6.6	5		6.8	7.9	8.8	9.7	9.4	7.3	6
64			5.6	7.6	8.7	8.2	6.3	4.8		5.7	6.9	7.8	8.7	9	7	5.7
66			3.5	6.6	7.7	7.9	5.9	4.5		4.6	5.9	6.8	7.7	8.1	6.7	5.4
68				5.6	6.8	7.4	5.6	4.3			5.1	5.9	6.8	7.2	6.4	5.2
70				4.4	5.9	6.6	5.4	4			4.4	5.1	5.9	6.4	6.1	5
72				2.8	5.2	5.7	5.2	3.8			3.3	4.5	5.2	5.5	5.8	4.8
74					4.6	5.1	5	3.6				3.8	4.6	4.9	5.4	4.6
76					3.5	4.5	4.8	3.5			2.1	3.8	4.4	4.8	4.8	4.4
78					2.2	3.9	4.3	3.3				3.1	4	4.3	4.2	4.2
80						3.3	3.8	3.1				2.2	3.3	3.7	3.5	3.6
82						2.5	3.3	2.6					2.6	3.1	3	3
84							2.6	2.8						2.5	2.4	2.5
86							2	2.6						1.9	2	2
88								2							1.9	2
90								1.4								1.5
ブーム伸長率 (%)	92								92							
	92								92							
	0								46							
	0								46							
	0								0							

*アダプター

TAB 218110



47.3m-78.6m



0°
6m-56m

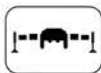

10m×9.6m



360°



165t



作業半径(m)	68.2m+2.2m*								78.6m+2.2m*					
	6m	14m	21m	28m	35m	42m	49m	56m	6m	14m	21m	28m	35m	42m
16	66													
18	61													
20	57	53												
22	52	47.5	42.5	32.5										
24	48	44.5	38.5	31	24.9									
26	44	42	36.5	28.6	22.9	18.1								
28	40.5	39	34.5	27.4	22	17.4	14.2							
30	37.5	36	33	26.4	21.1	16.7	13	11.1						
32	34.5	33.5	31	25.5	20.4	16	12.5	10.6						
34	31	31	29.6	24.6	19.7	15.4	12	10.2						
36	28	28.8	28	23.8	19	14.9	11.6	9.8						
38	25.5	26.8	26.1	22.9	18.3	14.4	11.1	9.4						
40	23	24.5	24.4	22	17.7	13.8	10.7	9						
42	20.5	22.4	22.6	21.1	17.2	13.4	10.3	8.7						
44	18.3	20.5	20.7	20.2	16.6	12.9	9.9	8.3						
46	16.5	18.7	19	19.1	16.1	12.5	9.6	8						
48	14.7	17	17.4	17.6	15.6	12.1	9.3	7.6						
50	12.9	15.4	15.9	16.1	15.1	11.7	9	7.4						
52	11.1	14	14.5	14.8	14.5	11.3	8.7	7.1						
54	9.7	12.5	13.2	13.5	13.6	10.9	8.4	6.9						
56	8.3	10.9	12	12.3	12.5	10.4	8.1	6.6						
58	7	9.4	10.8	11.2	11.4	9.9	7.8	6.4						
60	5.6	8.3	9.4	10.2	10.4	9.5	7.5	6.1						
62	4.3	7.1	8.1	9.2	9.4	9	7.3	5.9						
64	3.2	5.9	6.9	8.2	8.5	8.5	7.1	5.7						
66	2	4.7	5.9	7.3	7.7	7.7	6.9	5.5						
68		3.6	4.9	6.2	6.8	6.9	6.6	5.3						
70		2.7	3.8	5.3	6	6.2	6.4	5.1						
72		2	2.8	4.4	5.3	5.4	5.7	4.9						
74			1.8	3.5	4.6	4.8	5.4	4.7						
76				2.6	4	4.5	5.1	4.3						
78				1.7	3.2	3.5	3.8	3.7						
80					2.4	2.9	3.2	3.1						
82					1.6	2.3	2.6	2.6						
84						1.8	2.1	2.1						
86							1.6	1.5						
ブーム伸長率 (%)	92								92					
	92								92					
	92								92					
	46								92					
	46								92					

*アダプター

TAB 218110

550t

LIEBHERR LTM1550N

オールテレーンクレーン yonehara



47.3m-78.6m



20°
6m-42m



10m×9.6m



360°



165t



メインブーム長さ ジブ長さ	47.3m+2.2m*						57.7m+2.2m*					
	6m	14m	21m	28m	35m	42m	6m	14m	21m	28m	35m	42m
12	72											
14	67											
16	63	45					68					
18	60	44.5					65					
20	56	42.5					62	44.5				
22	54	41	27.2				59	43				
24	51	39.5	27				56	41.5				
26	49	38	26.3	17.9			52	40	27.2			
28	45.5	37	25.7	17.4			47.5	39	27.2	18.3		
30	40.5	36	25.1	17.1	13.7		44	38	27.2	18.2		
32	36	34.5	24.3	16.9	13.7	11.6	40.5	36.5	26.6	18.1	13.7	
34	32.5	34	23.5	16.7	13.7	11	37	36	25.7	18	13.7	
36	28.7	32.5	22.8	16.5	13.7	10.7	33.5	34.5	25	17.8	13.7	11.1
38	25.6	29.2	22.2	16.3	13.7	10.5	30.5	32	24.3	17.6	13.7	11
40	22.7	26.3	21.5	16.1	13.3	10.2	29.5	29.5	23.6	17.4	13.7	10.8
42	20.2	23.6	20.9	15.8	12.9	10	24.5	26.8	23	16.9	13.7	10.6
44	17.8	21.2	20.4	15.4	12.5	9.7	22	24.4	22.4	16.5	13.3	10.4
46	15.7	19	19.9	14.9	12.1	9.3	19.7	22.2	21.9	16	13	10
48	13.7	16.9	19.4	14.5	11.7	9	17.5	20.1	21.4	15.6	12.6	9.7
50		15	17.6	14.1	11.3	8.6	15.6	18.1	19.9	15.2	12.3	9.4
52		13.3	15.8	13.8	11	8.3	13.8	16.2	18.1	14.8	11.9	9.1
54		11.7	14.1	13.1	10.6	8	12.2	14.5	16.4	14.5	11.6	8.8
56		10.2	12.6	13.1	10.3	7.7	10.4	12.9	14.3	14.1	11.3	8.5
58			11.1	12.8	10	7.4	8.7	11.4	13.3	13.7	11	8.2
60			9.8	11.7	9.8	7.2	7.1	10.1	11.9	13.3	10.7	7.9
62			8.5	10.4	9.5	7		8.8	10.6	12.1	10.4	7.7
64			7.2	9.2	9.3	6.8		7.6	9.3	10.9	10.1	7.4
66				8	9.1	6.6		6.5	8.2	9.7	9.9	7.2
68				6.9	8.7	6.3		5.4	7.1	8.6	9.7	7
70					7.6	6.2			6	7.5	9	6.8
72					6.6	6			5.1	6.5	8	6.6
74					5.6	5.9			4.4	5.5	7	6.5
76					4.9	5.7				4.8	6.1	6.3
78						4.2				4.1	5.3	6.1
80										3.4	4.6	5.4
82										2.6	4	4.8
84											3.3	4.2
86											2.6	3.9
88											1.8	2.2
90												1.5
ブーム伸長率 (%)				92						92		
II				92						92		
III				92						92		
IV				0						46		
V				0						46		
VI				0						0		

*アダプター

TAB 218119



47.3m-78.6m



20°
6m-42m



10m×9.6m



360°



165t



メインブーム長さ ジブ長さ	68.2m+2.2m*						78.6m+2.2m*					
	6m	14m	21m	28m	35m	42m	6m	14m	21m	28m	35m	42m
18	60											
20	57											
22	53						34.5					
24	49						33					
26	45	40					31.5	25.1				
28	41.5	39	27.2				30	24.1				
30	38	36.5	26.1	17.9			28.5	23.2	18.6			
32	35.5	34.5	25.4	18.1			26.9	22.3	18.1			
34	33	32.5	24.7	17.8	13.7		25.2	21.5	17.6	11.6		
36	29.8	30	24.1	17.6	13.7		23.4	20.7	17	11.4		
38	27	28.1	23.5	17.3	13.7	10.7	21.6	20	16.3	11.2	8.9	
40	24.3	26.1	23	16.8	13.6	10.6	19.8	19.3	15.8	11.1	8.7	
42	21.6	24.4	22.5	16.4	13.3	10.3	18.4	18.7	15.3	10.9	8.6	7.3
44	19.6	22.3	22	16	13	10	17	18	14.7	10.8	8.4	7.2
46	17.6	20.4	21.3	15.6	12.6	9.7	15.7	17.4	14.2	10.6	8.3	7
48	15.5	18.6	19.8	15.3	12.3	9.4	14.4	16.8	13.8	10.5	8.1	6.9
50	13.6	17	18.2	14.9	12	9.1	13.1	16	13.4	10.3	8	6.8
52	12	15.4	16.6	14.6	11.7	8.9	11.8	14.9	12.9	10	7.9	6.6
54	10.5	14	15.2	14.3	11.4	8.6	10.6	13.9	12.5	9.7	7.8	6.5
56	8.9	12.5	13.9	13.9	11.2	8.4	9.3	12.8	11.9	9.4	7.6	6.4
58	7.4	11.2	12.6	13.6	10.9	8.1	8.1	11.7	11.3	9.1	7.4	6.3
60	6.1	9.9	11.4	12.4	10.7	7.9	6.9	10.5	10.6	8.7	7.2	6.2
62	4.8	8.7	10.2	11.3	10.4	7.7	5.7	9.3	10	8.3	7	6.1
64	3.6	7.4	9	10.3	10.2	7.5	4.6	8	9.4	7.8	6.9	5.9
66		6.2	8	9.2	10	7.3	3.4	6.7	8.4	7.3	6.7	5.8
68	2.3	4.9	7	8.2	9.2	7.1	2.5	5.4	7.4	6.8	6.4	5.7
70		3.7	6	7.2	8.3	6.9	1.8	4.4	6.3	6.3	6.1	5.6
72		2.7	4.9	6.3	7.3	6.7		3.4	5.2	5.7	5.8	5.5
74		1.7	3.8	5.4	6.4	6.5		2.5	4.2	4.8	5.5	5.3
76			2.6	4.8	5.6	6.2			3.3	4	5.2	5.1
78			1.9	3.8	4.9	5.5			2.6	3.2	4.7	4.9
80				2.8	4.3	4.9				2.4	4	4.7
82				1.8	3.7	4.3				2	3.2	4.5
84					3	3.6				1.6	2.5	4.3
86					2.2	3					1.7	3.3
88					2	2.4						2.7
90					2	1.8						2
92												1.3
ブーム伸長率 (%)				92						92		
II				92						92		
III				92						92		
IV				92						92		
V				46						46		
VI				46						46		

*アダプター

TAB 218119

550t

LIEBHERR LTM1550N

オールテレーンクレーン

yonehara



47.3m-
78.6m



40°
6m-
35m



10m×9.6m



360°



165t



メインブーム長さ		47.3m+2.2m*					57.7m+2.2m*				
ジブ長さ		6m	14m	21m	28m	35m	6m	14m	21m	28m	35m
作業半径(m)											
14		47									
16		45.5					46				
18		44					44.5				
20		42.5	28.3				43.5				
22		41.5	28				42.5				
24		40.5	27.4	16.5			41.5	27.6			
26		39.5	26.8	16.7			40.5	27.6			
28			26.3	16.9			40	27.1			
30		38	25.9	17	9.9		39	26.6	16.2		
32		37	25.5	16.7	10		37.5	26.2	16.5		
34		33	25.1	16.4	10.1		34.5	25.8	16.8	9.9	
36		29.4	24.8	16.1	10.2	7.7	31	25.5	16.7	10.1	
38		26.1	24.5	15.8	10.4	7.7	28	25.1	16.4	10.3	
40			24.3	15.5	10.4	7.8	25.1	24.8	16.1	10.5	7.3
42			24.2	15.3	10.3	7.7	24.6	24.6	15.9	10.5	7.4
44			22.3	15.1	10.2	7.7	22.5	24.4	15.6	10.5	7.5
46			19.9	14.9	10.1	7.6	20.1	23.6	15.4	10.5	7.7
48				14.8	9.9	7.4	17.9	21.3	15.2	10.3	7.6
50				14.7	9.8	7.2		19.1	15	10.1	7.5
52				14.5	9.6	7		17.2	14.8	10	7.4
54					9.5	6.9		15.3	14.7	9.8	7.2
56				14.5	9.4	6.7		13.6	14.6	9.7	7.1
58					9.3	6.6			14.5	9.6	6.9
60					9.3	6.5			13	9.4	6.8
62						6.4			11.5	9.4	6.7
64						6.4				9.3	6.6
66						6.3				9.2	6.5
68						6.3				9.2	6.4
70										8.6	6.4
72											6.3
74											6.2
	I			92					92		
	II			92					92		
	III			92					92		
	IV			0					46		
	V			0					46		
	VI			0					0		

*アダプター

TAB 218128



47.3m-
78.6m



40°
6m-
35m

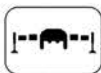

10m×9.6m



360°



165t



メインブーム長さ		68.2m+2.2m*					78.6m+2.2m*				
ジブ長さ		6m	14m	21m	28m	35m	6m	14m	21m	28m	35m
作業半径(m)											
20		43									
22		42.5					33.5				
24		41.5					32				
26		40.5	26.8				30.5				
28		40	26.4				29.4				
30		38.5	26	16			28.3	21.1			
32		36	25.7	16.6			26.9	20.9			
34		33.5	25.4	16.6			25.3	20.4	12.9		
36		31	25.1	16.4	9.8		23.8	19.8	12.9		
38		28.3	24.8	16.1	10.1		22.2	19.2	12.9		
40		25.6	24.6	15.9	10.3		20.6	18.6	12.9	7.4	
42		22.9	24.4	15.7	10.5	7.2	18.9	18	12.9	7.4	
44		20.5	23.7	15.5	10.5	7.4	17.5	17.5	13	7.5	
46		18.4	21.8	15.3	10.3	7.4	16.2	17	13	7.5	
48		16.3	19.9	15.1	10.1	7.5	14.9	16.4	13	7.5	5.2
50		14.3	18.2	14.9	10	7.4	13.6	15.9	12.7	7.5	5.2
52		12.6	16.5	14.8	9.9	7.3	12.3	15.2	12.4	7.6	5.2
54			14.9	14.7	9.7	7.1	11	14.2	12	7.6	5.2
56			13.3	14.6	9.6	7	9.8	13.3	11.7	7.6	5.3
58			11.9	14	9.5	6.9	8.5	12.4	11.3	7.6	5.3
60			10.6	12.6	9.4	6.8	7.2	11.4	10.8	7.6	5.3
62				11.3	9.3	6.7		10.1	10.3	7.5	5.3
64				10	9.2	6.6		8.8	9.9	7.5	5.4
66				8.8	9	6.5		7.5	9.4	7.3	5.4
68				7.7	8.5	6.4		6.1	8.5	7	5.4
70					8	6.3			7.3	6.7	5.4
72					7.4	6.3			6.2	6.4	5.3
74					6.4	6.2			5.1	6	5.2
76						6.1				5.1	5.1
78						6				4.2	4.9
80						5.2				3.3	4.7
82						4.5				2.5	4
84											3.3
86											2.6
88											1.9
	I			92					92		
	II			92					92		
	III			92					92		
	IV			92					92		
	V			46					92		
	VI			46					92		

*アダプター

TAB 218128

550t

LIEBHERR LTM1550N

オールテレーンクレーン yonehara

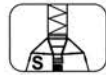

メインブーム長さ		47.3m+2.2m*			57.7m+2.2m*			68.2m+2.2m*		
ジブ長さ		6m			6m			6m		
角度		0°	20°	40°	0°	20°	40°	0°	20°	40°
作業半径(m)	9	119								
	10	113								
	12	100	70	42	87					
	14	89	66	40.5	78	66	40.5	66		
	16	81	61	39	71	62	39.5	61	60	
	18	73	58	37.5	65	59	38	56	56	38.5
	20	66	54	36.5	60	56	37	52	53	37.5
	22	59	51	35	55	54	36	48.5	49	36.5
	24	54	48	34	50	51	35	45	45.5	35.5
	26	49	45.5	33.5	45.5	47	34	42	42.5	35
	28	43.5	43.5	32.5	42	43.5	33.5	39	39.5	34
	30	39	40	31.5	39	40	32.5	36	37	33.5
	32	34.5	36	31	35.5	37	32	33.5	34.5	33
	34	31	32	30.5	32	33.5	31.5	31	32	32
	36	27.4	28.5	29.1	29	30	31	28.8	29.8	30.5
	38	24.4	25.3	25.9	26.2	27.2	27.8	26.7	27.7	28.5
	40	21.6	22.5	22.9	23.4	24.3	24.9	24.2	25.2	25.9
	42	19.2	19.9		20.9	21.8	22.3	22	22.9	23.6
	44	17	17.6		18.7	19.5	19.9	20	20.8	21.4
	46	14.9	15.5		16.7	17.4	17.8	18.1	18.9	19.4
	48	13.1	13.5		14.8	15.4	15.8	16.4	17	17.5
	50	10.8			13.1	13.7		14.6	15.3	15.7
	52	6.3			11.5	12		13.1	13.6	14
	54				10.1	10.5		11.6	12.1	12.4
	56				8.7	9.1		10.2	10.7	11
	58				7.5	7.8		9	9.4	
	60				5.3			7.8	8.2	
	62							6.7	7.1	
	64							5.6	6	
	66							4.9	5.1	
	68							3.9	3.7	
	70									
	72									
	74									
	76									
	78									
ブーム伸長率 (%)	I		92			92			92	
	II		92			92			92	
	III		92			92			92	
	IV		0			46			92	
	V		0			46			46	
	VI		0			0			46	

*アダプター

TAB 231499/231501/231503/231506/231508/231510

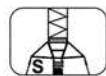

メインブーム長さ		73.4m+2.2m*			78.6m+2.2m*		
ジブ長さ		6m			6m		
角度		0°	20°	40°	0°	20°	40°
作業半径(m)	14	59					
	16	55					
	18	52	50		47		
	20	49	47.5		44.5	40.5	
	22	46	45		42	38.5	
	24	43	42.5		40	37	
	26	40	40.5		38	35.5	
	28	37.5	38		36	34.5	
	30	35	35.5		35	33	
	32	33	33		33	32	
	34	31	31.5		31	30.5	
	36	28.8	29.4		29	28.8	
	38	26.6	27.4		27.2	27.1	
	40	24.2	25.1		25.4	25.6	
	42	22.1	22.9		23.7	24.1	
	44	20.1	20.9		22.1	22.7	
	46	18.3	19		20.5	21.2	
	48	16.6	17.3		18.8	19.5	
	50	15	15.7		17.1	17.8	
	52	13.6	14.2		15.6	16.3	
	54	12.1	12.7		14.2	14.8	
	56	10.7	11.3		12.8	13.4	
	58	9.5	10		11.6	12.1	
	60	8.3	8.8		10.3	10.8	
	62	7.2	7.6		9.2	9.6	
	64	6.2	6.6		8.1	8.5	
	66	5.3	5.5		7	7.4	
	68	4.6	4.8		6.1	6.4	
	70	3.8	4.1		5.2	5.5	
	72	3	3.2		4.5	4.8	
	74				3.9	4.1	
	76				3.1	3.3	
	78				2.3	2.5	
ブーム伸長率 (%)	I		92			92	
	II		92			92	
	III		92			92	
	IV		92			92	
	V		92			92	
	VI		46			92	

*アダプター

TAB 231499/231501/231503/231506/231508/231510

550 t

LIEBHERR LTM1550N
オールテレーンクレーン **yonehara**



550t

LIEBHERR LTM1550N オールテレーンクレーン yonehara

外観寸法

単位：mm

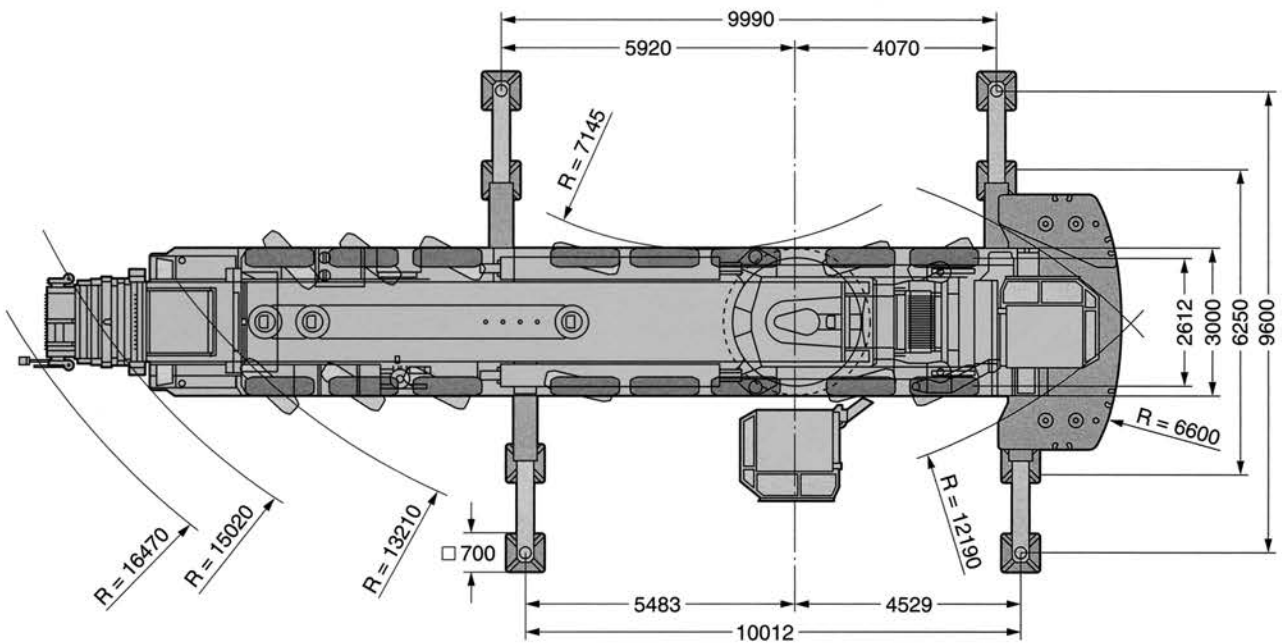
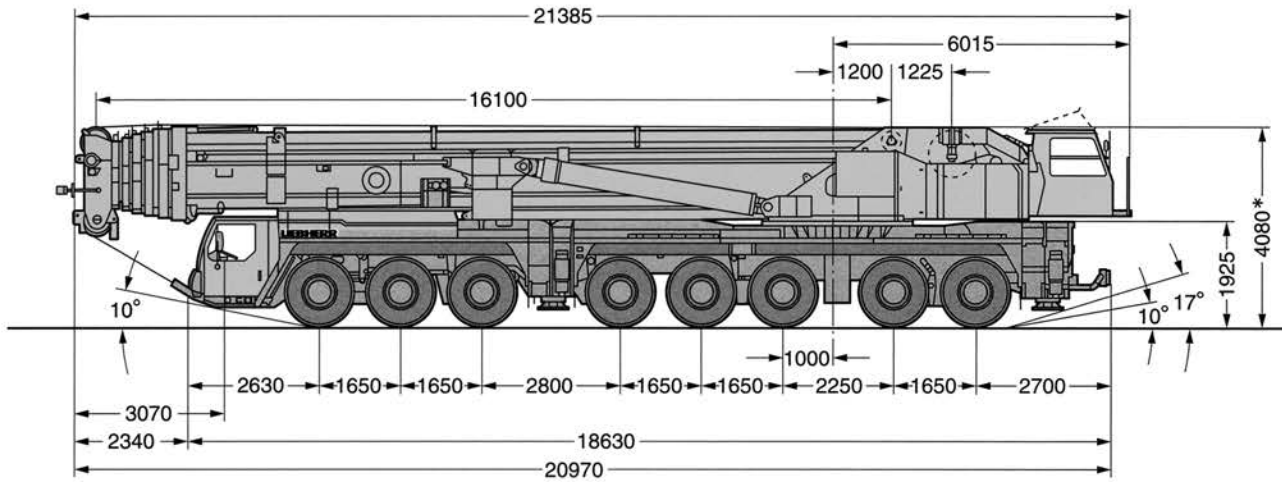

図はメインブーム84m仕様ですが、
メインブーム50m仕様でも外形寸法は変わりません。
*クイックコネクション装備

本機は、公道を走行する場合、メインブーム及び旋回体を別送としてクレーン台車のみで走行しなければなりません。